

# SKIPPER ES-7100

## 10,4" DUAL FREQUENCY LCD ECHO SOUNDER

### OPERATION AND INSTALLATION MANUAL

Edition : 20040105

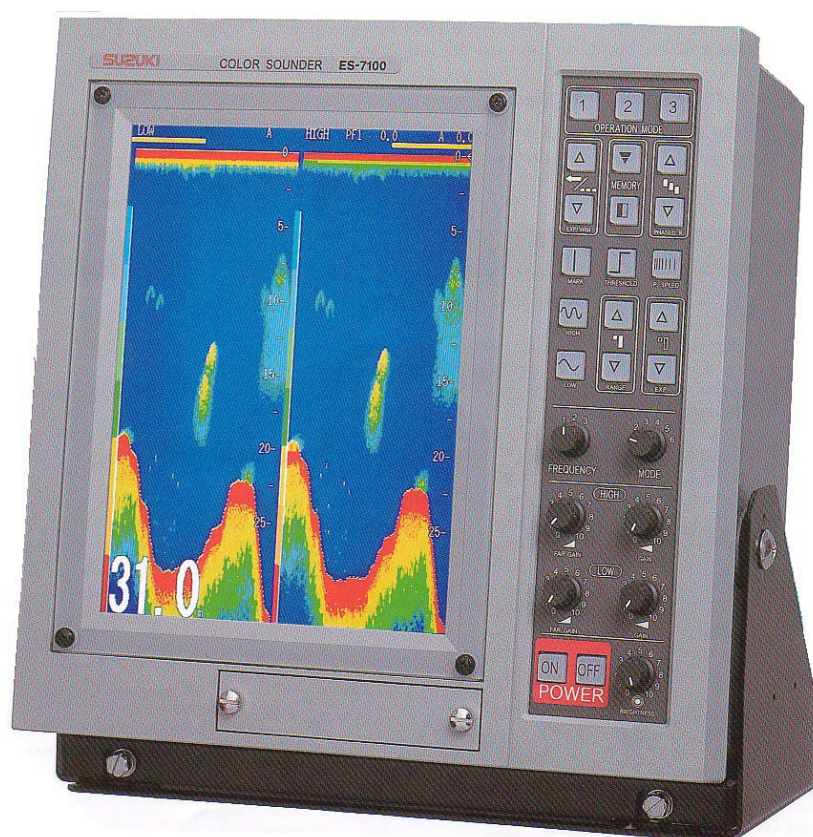

Skipper Electronics A/S  
Ryensvingen 5  
P.O.Box 151, Manglerud  
0612 Oslo, Norway  
[www.skipper.no](http://www.skipper.no)

Telephone +47 23 30 22 70  
Telefax +47 23 30 22 71  
E-mail: [skipper@skipper.no](mailto:skipper@skipper.no)  
Co.reg.no: NO-965378847 -MVA

**SKIPPER**

# CONTENTS

Chapter 1	2
INTRODUCTION	
BEFORE OPERATION	3
FOR YOUR SAFETY	4
SUPPLIED COMPONENTS	6
INSTALLATION	7
FUNCTION EXPLANATION	11
MODE EXAMPLE	12
Chapter 2	13
INITIAL SETTINGS	
FACTORY SETTINGS	14
Chapter 3	17
FUNCTION SETTINGS	
RANGE SETTINGS	19
FUNCTION SETTINGS	21
Chapter 4	57
FRONT CONTROL PANEL OPERATION	
DISPLAY MODE	58
DIAL OPERATION	59
KEY OPERATION	68
Chapter 5	76
OPTION	
OPTIONAL CONNECTOR KIT	76
INTERFACE CONNECTIONS	77
SPECIFICATIONS	78

# Chapter 1

## INTRODUCTION

Thank you for purchasing the ES-7100.

This operation manual provides complete information on safely operating

the high performance Color Echo Sounder ES-7100

to its full potential.

Before operating this equipment, please read this manual thoroughly to understand the operation to avoid any trouble and possible injury in advance.

<b>BEFORE OPERATION</b>	SYMBOLS .....	3
	CAUTION NOTE .....	3
	KEYBOARD DESCRIPTION .....	3
<b>FOR YOUR SAFETY</b>	ENVIRONMENTAL CONDITIONS .....	4
	CONVENIENT LOCATION .....	4
	POWER REQUIREMENTS .....	5
	HANDLING .....	5
<b>SUPPLIED COMPONENTS</b>	COMPOSITION .....	6
<b>INSTALLATION</b>	DIMENSIONS .....	7
	MAIN UNIT MOUNTING .....	8
	REAR PANEL .....	9
	CONNECTIONS .....	10
<b>FUNCTION EXPLANATION</b>	CONTROL PANEL .....	11
<b>MODE EXAMPLE</b>	DISPLAY .....	12

# BEFORE OPERATION

## SYMBOLS

- ◎ The following conventions are used in this manual.

Before using this unit, make sure to understand the following, which are used throughout this manual.



: indicates and imminently hazardous situation which, if not avoided, will result in death or serious injury.



: indicates a potentially hazardous situation which, if not avoided, will result in death or serious injury.



: indicates precautionary measures to avoid potential problems.

NOTE !

: indicates contents for the user's reference.

**cf**

: see the page.

## CAUTION NOTE

- ◎ This manual contains important information about the ES-7100.
- ◎ In order to fully understand the operation, and know detailed information for your safety, please read this manual carefully.
- ◎ Keep this operation manual in a safe place where it is easy to find.  
When you give this unit to someone else, make sure to give this manual, too.
- ◎ Any use other than that mentioned in this manual is not guaranteed.
- ◎ The contents in this manual are subject to change without notice or obligation.
- ◎ Please contact us if you should have any questions regarding the use of this equipment.

## KEYBOARD DESCRIPTION

- ◎ One beep will advise you when a right function is performed.  
Three beeps will advise you when a wrong operation or a wrong key is pressed.

# FOR YOUR SAFETY

---

## ENVIRONMENTAL CONDITIONS

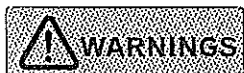

- ⊙ Keep the equipment away from flammable gas.  
It will cause fire.



- ⊙ Pay attention to the following environmental conditions on mounting, otherwise the equipment may become heated causing trouble and malfunction.
  - It is recommended that it will be mounted in a location which provides protection from spray or heavy vibration.
  - Do not bring any other heated object close to the equipment,
- ⊙ Do not bring any magnetic object close to the equipment.

## CONVENIENT LOCATION



- ⊙ Find a convenient location. The ES-7100 may be mounted upright on any level surface and tighten securely.
- ⊙ Make sure the following on wiring. Otherwise damage or fire may occur.
  - Take care of connecting the cables not to be disturbed the operation.
  - Do not use the cables bent, twisted or stretched by force.
  - Do not put heavy objects on the cables.



- ⊙ When removing/plugging in cables, make sure to turn the power off. Never pull cables, otherwise it may damage the unit and result in fire or electrical shock.

## POWER REQUIREMENTS

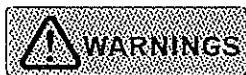

- ⊙ Operating voltage: 10.5 to 40 volts DC

Please use correct voltage, otherwise, it will lead to fire or electric shock, or damage to the unit.



- ⊙ Make sure to turn off the power by the power "ON/OFF" keys on the control panel. Turning on/off the power by the ships switchboard may damage the unit or cause problems with operations.
- ⊙ When starting the vessels engine, make sure the power of this unit is turned off, otherwise it may cause problems with the unit.

## HANDLING



- ⊙ Do not control this unit while steering.  
It could result in collision and serious injury or damage.
- ⊙ Do not open the main unit case.  
Otherwise electrical shock, damage, and serious bodily injury to user may result.  
For inspection/adjustment/parts installation/repair, please ask your dealer. There is a high voltage component inside, and it will result in electric shock.
- ⊙ The sufficient reinforcement and water tightness should be made when installing the transducer.  
It could result in collision and serious injury or damage.

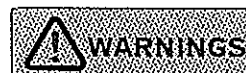







- ⊙ Please use the specified fuse.  
If not, it could result in malfunction and / or fire.
- ⊙ Please use the specified power supply cable cords.  
Using cables other than those specified could generate heat and result in burns, bodily injury and fire.
- ⊙ When replacing batteries,
  - Insert new batteries. Be sure that the polarity (+, -) is correct.
  - Never subject batteries to very hot or cold temperatures, or disassemble or dump into fire/water,
  - Never use batteries with fluid leaking out.

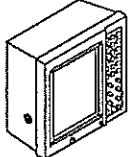
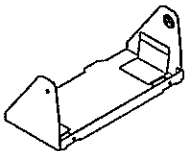
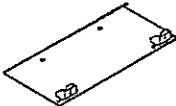

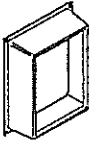

# SUPPLIED COMPONENTS

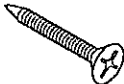
## COMPOSITION

The following items are shipped with the unit.

CODE	** RD110				** RD130
ITEM	MAIN UNIT 	MOUNTING BRACKET 	MOUNTING PLATE 	HEXAGONAL BOLT 	HOOD 
PARTS#	—	34808C	34556C	M6 X 20	34535C-Assy
QTY	1	1	1	2	1

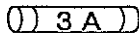
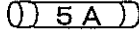
CODE	** RD001				
ITEM	TRUSS SCREW 	TAPPING SCREW 		POWER SUPPLY CABLE  2m	3P PLUG 
PARTS#	M8 X 15	M5 X 30		31524D	HS21P-3
QTY	2	6		1	2

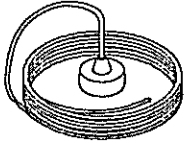
CODE	** RA121				
ITEM	MANUAL 	UNIT COVER 	POWER FUSE   		TRANSDUCER ETC. 
PARTS#	ES7100-OPM-E	ES7100-COV	—		TD related parts
QTY	1	1	3 EACH		when required.

NOTE : The code number is shown on the packages. However, \*\* indicates the lot management number.

# INSTALLATION

## DIMENSIONS

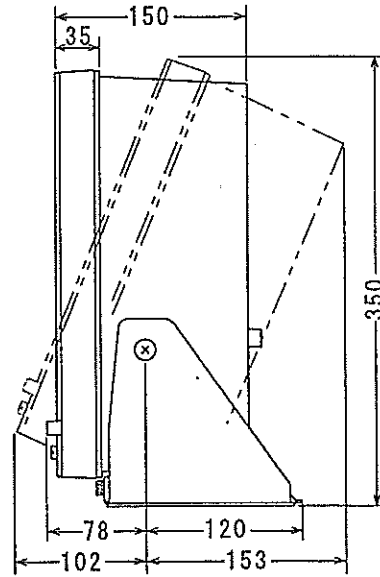
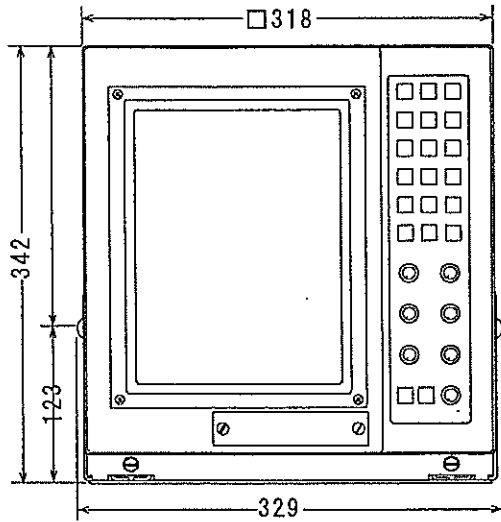

WEIGHT : 9 kg (including mounting bracket)

## TEMPLATE FOR INSTRUCTIONS

(MOUNTING PLATE)

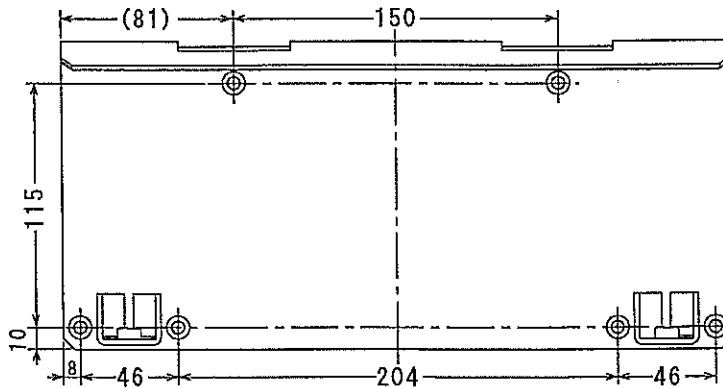



# MAIN UNIT MOUNTING

- ① Using the attached tapping screws (6 pcs), secure the mounting plate to the site selected.
- ② Adjust the truss screws (2 pcs) to select a comfortable viewing angle of the display unit.
- ③ Insert the cabinet with the bracket into the gutter of the mounting plate. Tighten 2 hexagonal bolts at the notches.

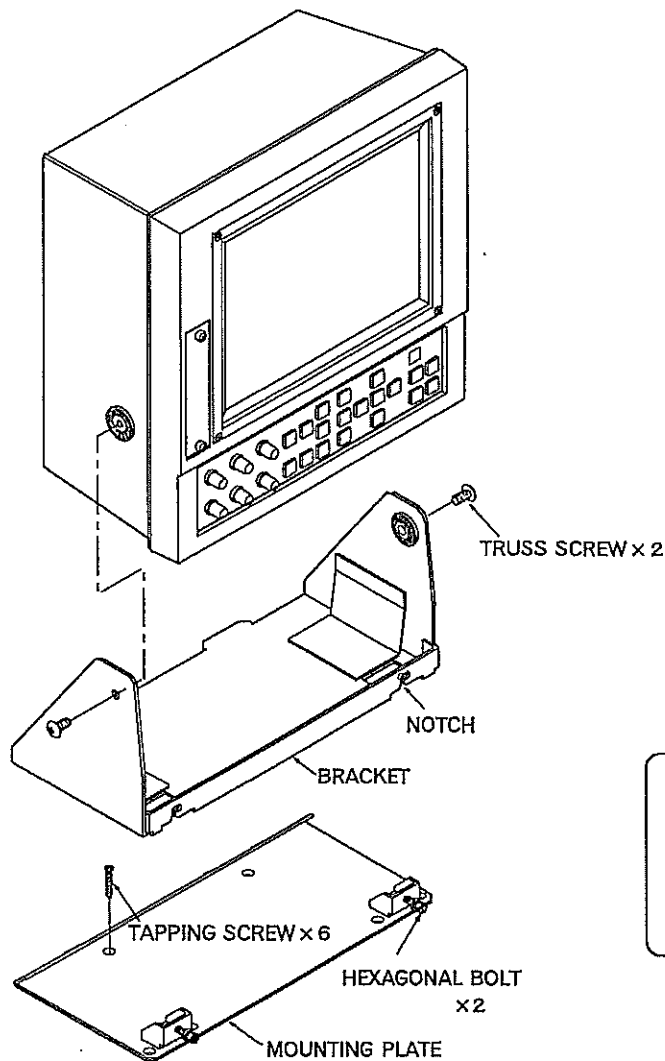

MAIN CABINET with ACCESSORIES

DISPLAY CABINET.....	1
BRACKET.....	1
MOUNTING PLATE.....	1
TRUSS SCREW (M8-15).....	2
TAPPING SCREW (M5-30).....	6
HEXAGONAL BOLT(M6-20).....	2



⊙ The unit should be installed on a flat surface. Do not use the unit while tentatively installed, otherwise it may cause trouble.



- ⊙ Make sure the unit is not close to any inverters, converters, or transformers that interfere with the sonar performance.
- ⊙ Install the unit in a location away from salt spray, heat sources and direct sunlight.

# REAR PANEL

IN/OUT TERMINALS (OPTION)  
 • Refer to the page 76.

4 PIN TEMPERATURE  
 SENSOR CONNECTOR  
 • To connect temp. sensor  
 (OP-102)

3 PIN TRANSDUCER  
 CONNECTOR  
 • To connect transducers  
 (high/low frequency)

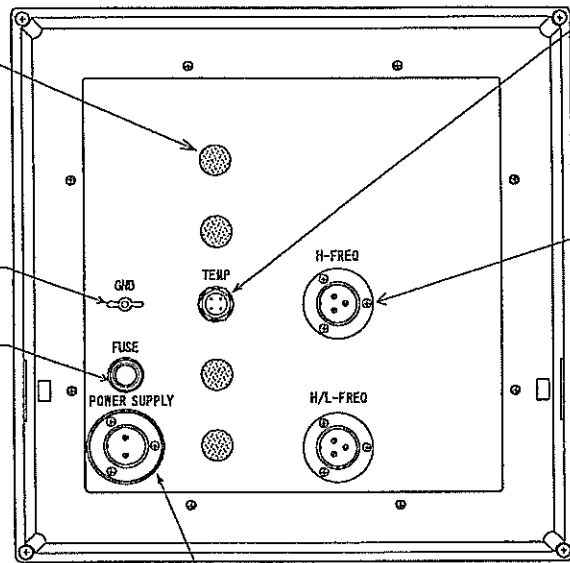

EARTH  
 TERMINAL

FUSE HOLDER  
 • Please use fuses as follows:  
 12V → 8A  
 24V → 5A  
 32V → 3A  
 When changing the voltage,  
 please change to the  
 correct fuse.

2 PIN POWER SUPPLY CONNECTOR  
 • Operating voltage: 10.5 to 40 volts DC

# CONNECTIONS

CONNECTION for TEMP. SENSOR (4P)

PIN	SIGNAL
No. 1	WHITE
No. 2	SHIELD
No. 3	NC
No. 4	BLACK

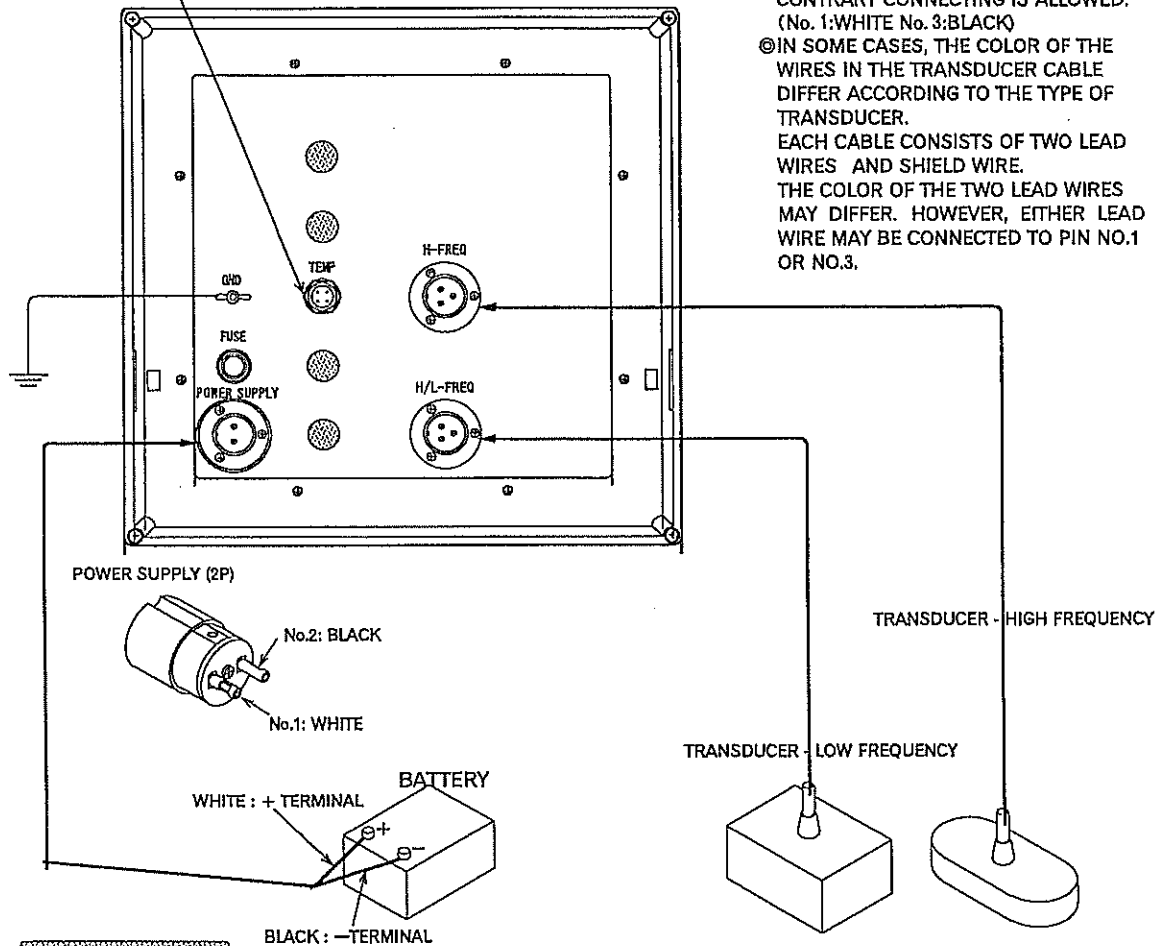

CONNECTION CABLE TERMINAL for TRANSDUCER (3P)

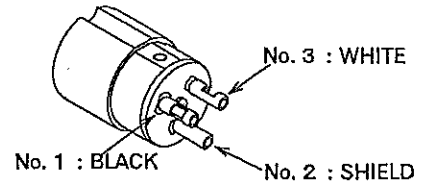

- ⊙ IN THE CASE OF PIN NO. 1 AND NO. 3, CONTRARY CONNECTING IS ALLOWED. (No. 1:WHITE No.3:BLACK)
- ⊙ IN SOME CASES, THE COLOR OF THE WIRES IN THE TRANSDUCER CABLE DIFFER ACCORDING TO THE TYPE OF TRANSDUCER. EACH CABLE CONSISTS OF TWO LEAD WIRES AND SHIELD WIRE. THE COLOR OF THE TWO LEAD WIRES MAY DIFFER. HOWEVER, EITHER LEAD WIRE MAY BE CONNECTED TO PIN NO.1 OR NO.3.



- ⊙ Power requirement: DC10.5 - 40V, Using any power voltage other than the indicated voltage can cause it to lead to fires or electric shocks.
- ⊙ Use the indicated power supplied cables. Using any power supplied cable other than the indicated cable can cause it to lead to fires.
- ⊙ The ES-7100 must be turned off while connecting/disconnecting the cables. Otherwise the cables may be damaged and result in fires or electric shocks.
- ⊙ Do not use the cables bent, twisted or stretched by force. Do not put heavy objects on the cables. Otherwise the cables may be damaged and result in fires or electric shocks.

# BETJENINGS PANEL

Lagrer bruker innstillinger.  
Side.68

Ekspansjon :  
Valg av øvre start punkt for  
ekspansjon. Side.69

Markør linje. Lager en vertikal  
linje på skjermen.  
Side.73

Innstilling av høy frekvens.  
Side.74

Innstilling av lav frekvens.  
Side.74

Innstilling av frekvens.  
Side.59

Far Gain:  
Justerer forsterkningen på  
dypt vann.  
Side.66/67

AV-PÅ knapp:  
Hold knappen inne til  
bilde kommer på skjerm.

Lagrer innstillinger/ Leser Innst.  
\*Lagrer data fra Høyre side av  
skjerm.  
\*Viser data på venstre side av  
skjerm.  
Side.68

Fasing.  
Side.70

Terskel: Side.74  
valg av farger som skal vises.

Bildehastighet.  
Side.72

Ekspansjon knapp.  
Side.75

Dybde instilling.  
Side.70

Valg av bilde på skjerm.  
Side.60

FORSTERKNINGS KONTROLL.  
Justerer av forsterkningen på  
innkommende ekko.  
Side.65

Lysstyrke.  
Side.64

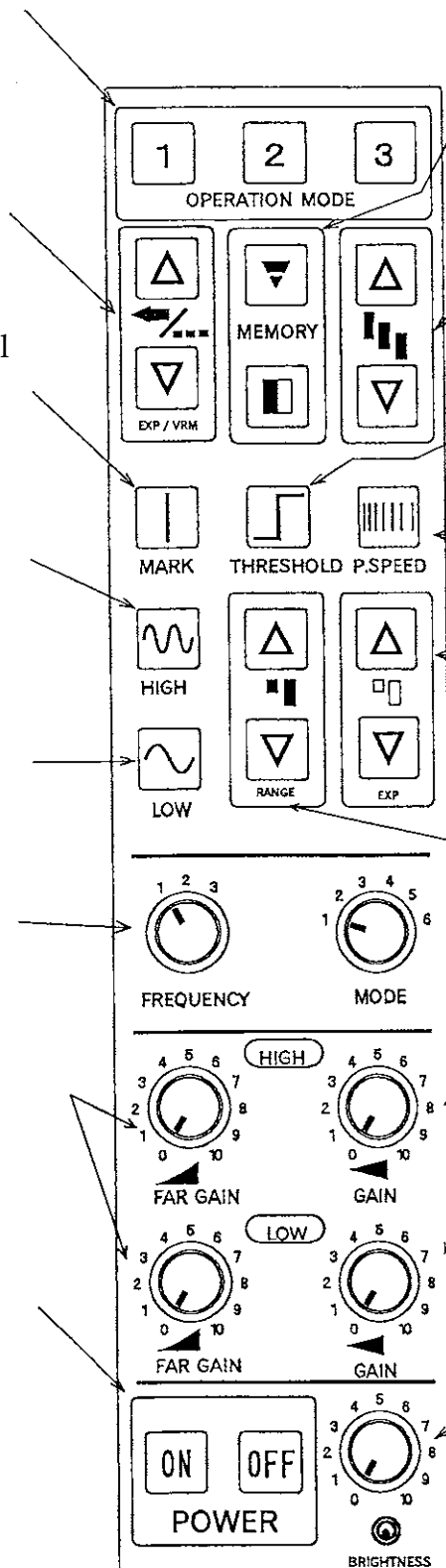

# BILDE FORKLARING :

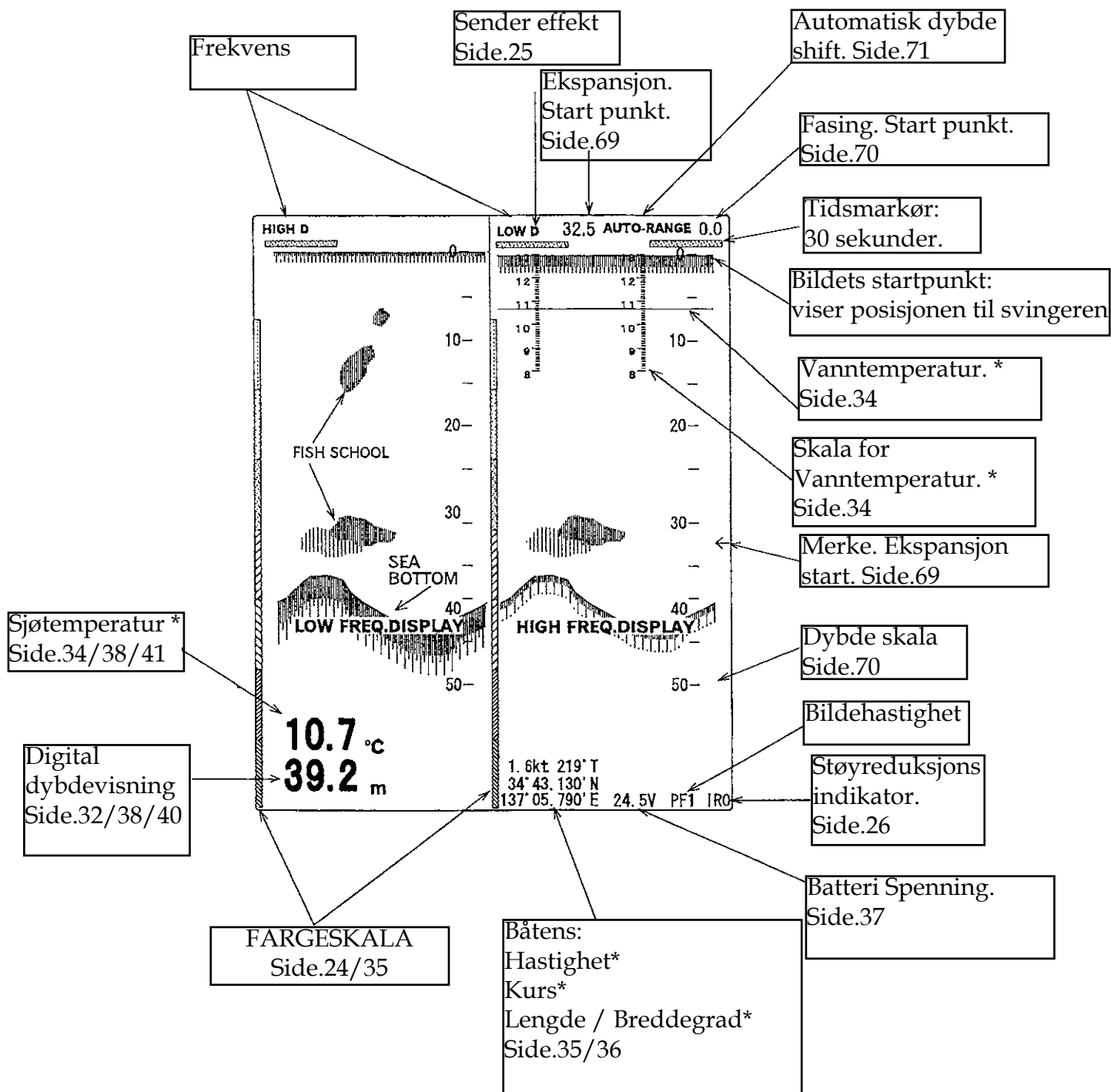

NB:! \* Ekstra utstyr må tilkobles.

# FUNCTION EXPLANATION

## CONTROL PANEL

### OPERATION MODE KEY:

- Calls up the user-defined setting or changes the settings.

**CF** PAGE 68

### EXPANSION / VRM KEY:

- Selects the upper expansion start point for Partial expansion mode.

**CF** PAGE 69

### MARK KEY :

**CF** PAGE 73

- Enters a vertical mark on the display.

### HIGH FREQUENCY KEY :

- Adjusts and changes the functions of the high frequency.

**CF** PAGE 74

### LOW FREQUENCY KEY :

- Adjusts and changes the functions of the low frequency.

**CF** PAGE 74

### FREQUENCY SELECTION

**DIAL :** **CF** PAGE 59

- Select the frequency.

### FAR GAIN DIAL :

**CF** PAGE 66/67

- Adjusts presentation of received echo in the long range.

### POWER KEY :

- Turns on or off the power.
- To turn on the power, press and hold the ON key till a picture appears on the screen.
- To turn the power off, hold OFF key for a while.

### MEMORY WRITE / READ KEY :

**CF** PAGE 68

- MEMORY WRITE KEY inserts data of the right half of the screen.
- MEMORY READ KEY displays insertion of data on the left side of the screen.

### PHASED RANGE KEYS :

**CF** PAGE 70

- Adjust the scale/range of depth between available values.

### THRESHOLD KEY :

**CF** PAGE 74

- Displays and erases colors from the color threshold.

### PICTURE SPEED KEY :

**CF** PAGE 72

- Selects the rate of picture movement.

### EXPANSION RANGE KEY :

**CF** PAGE 75

- Selects the expansion ranges for Partial and Bottom expansion modes.

### RANGE KEY :

**CF** PAGE 70

- Selects the basic range for Normal mode.

### MODE SELECTION DIAL :

**CF** PAGE 60

- Selects the display mode.

### GAIN DIAL :

**CF** PAGE 65

- Adjusts presentation of received echo.

### BRIGHTNESS DIAL :

**CF** PAGE 64

- Select the level of brightness.

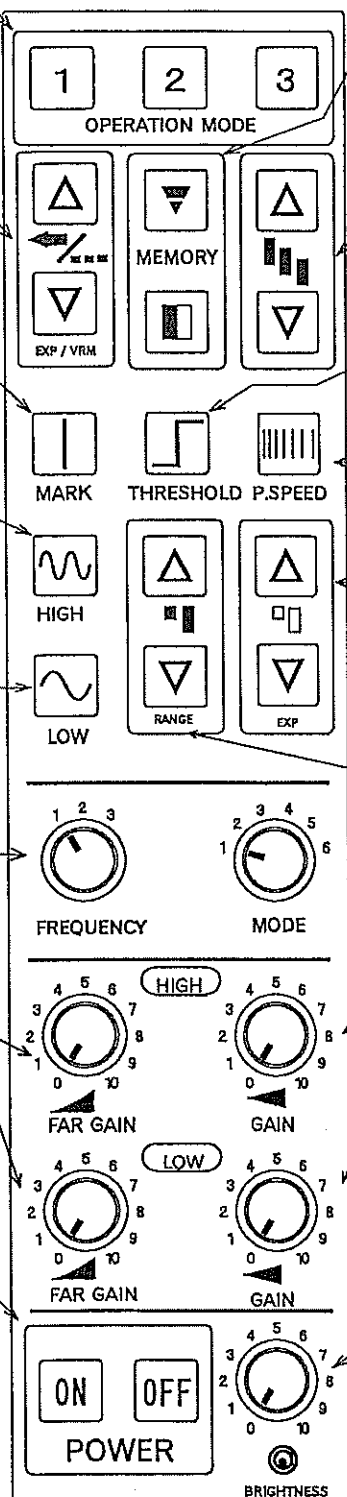

# MODE EXAMPLE

## DISPLAY

- ◎ The below shows an example for Normal mode.  
 Bottom expansion mode and partial expansion mode are different from this display.

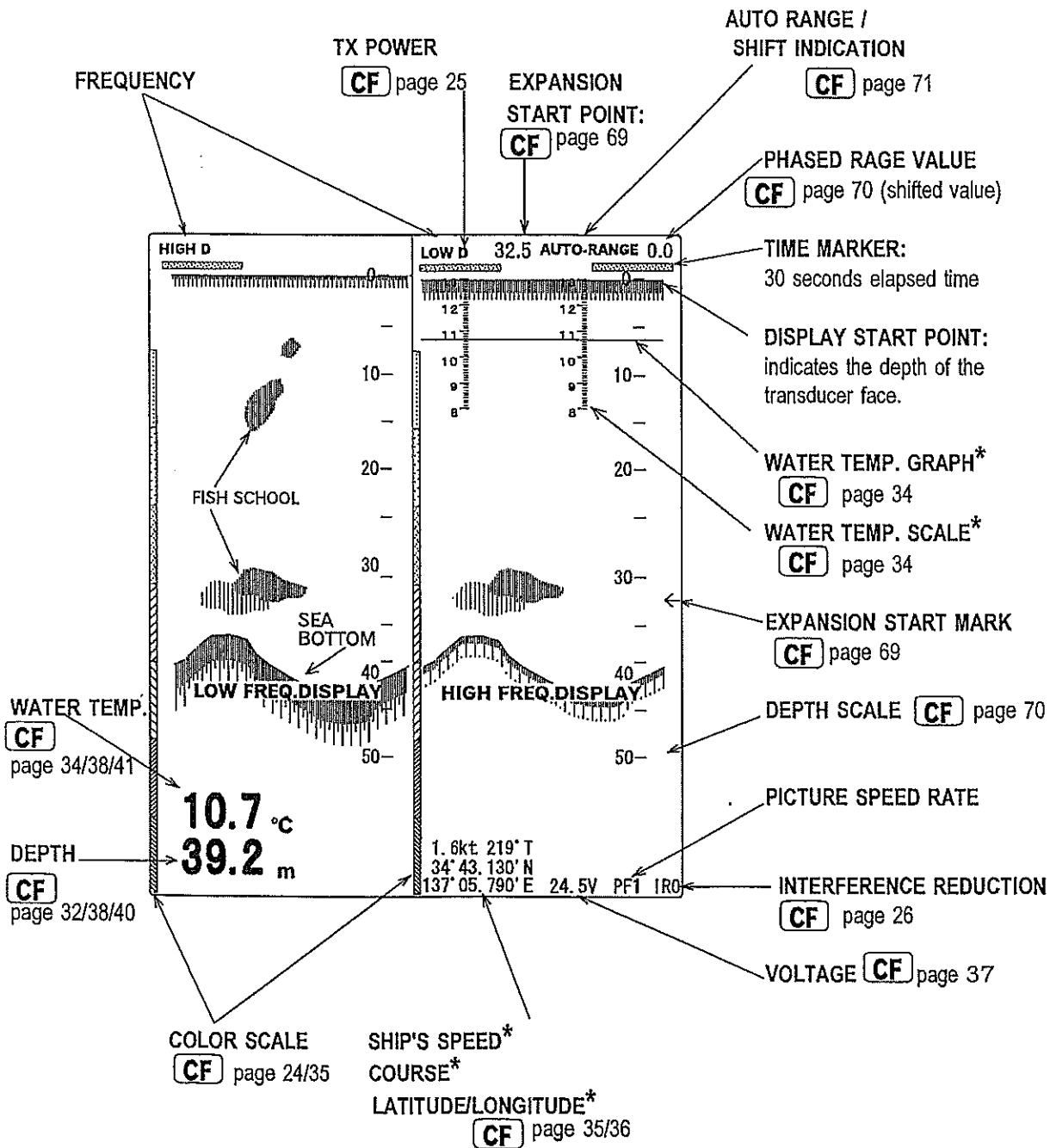

NOTE : \* Optional equipments required

## INITIAL SETTINGS

This chapter explains the initial function settings and return to factory settings of the ES-7100 Echo sounder.

### INITIAL SETTINGS

FACTORY SETTINGS .....	14
RETURN TO FACTORY SETTINGS .....	16
(INITIAL SETTINGS)	
USER SETTINGS .....	16



# INITIAL SETTINGS

## FACTORY SETTINGS

⊙ This equipment is shipped from the factory with the functions under the following settings. The user is able to re-set these function if/as desired with the user setting mode, MODE SELECTION DIAL 6.

1/2

FUNCTION	FACTORY SETTING ( in the box)	USER MODE
<b>FUNCTION SET • LOW</b> GAIN UP TVG D RANGE (DYNAMIC RANGE) CLUTTER TX POWER	OFF • +10 • <input type="checkbox"/> +20 • +30 • +40 STC • 1 • 2 • <input type="checkbox"/> 3 • 4 -3dB • -4dB • -5dB • <input type="checkbox"/> ±6dB • +5dB • +4dB • +3dB <input type="checkbox"/> OFF • 1 • 2 • 3 • 4 • 5 • 6 • 7 • 8 • 9 • 10 A • B • C • <input type="checkbox"/> D	<b>MODE SELECTION DIAL 6</b>
<b>FUNCTION SET • HIGH</b> GAIN UP TVG D RANGE (DYNAMIC RANGE) CLUTTER TX POWER	OFF • +10 • <input type="checkbox"/> +20 • +30 • +40 STC • 1 • 2 • <input type="checkbox"/> 3 • 4 -3dB • -4dB • -5dB • <input type="checkbox"/> ±6dB • +5dB • +4dB • +3dB <input type="checkbox"/> OFF • 1 • 2 • 3 • 4 • 5 • 6 • 7 • 8 • 9 • 10 A • B • C • <input type="checkbox"/> D	<input type="checkbox"/> CF page 21-25
<b>REDUCTION</b> INTERF RED JAMING RED NOISE RED WHITE LINE	<input type="checkbox"/> OFF • LOW • MIDDLE • HIGH <input type="checkbox"/> OFF • 1 • 2 • 3 • 4 • 5 • 6 • 7 • 8 • 9 <input type="checkbox"/> OFF • ON <input type="checkbox"/> OFF • LOW • MIDDLE • HIGH	<input type="checkbox"/> CF page 26-28
<b>SCREEN DIVISION</b> BTM EXPN SCREEN DIV DUAL FREQ (VERT. SPLIT) (HORIZ. SPLIT)	<input type="checkbox"/> CONST1 • CONST2 • CONST3 • AUTO <input type="checkbox"/> VERT • HORIZ <input type="checkbox"/> L   H • H   L <input type="checkbox"/> L / H • <input type="checkbox"/> H / L	<input type="checkbox"/> CF page 29-31
<b>DISP ITEM SEL</b> DEPTH DISP SCALE EXP/VRM TEMP DISP TEMP GRAPH COL. SCALE LAT.LONG. SPEED DISP COURSE VOLT DISP MARK DISP.POS DEPTH GRID PICTURE FEED A-SCOPE	OFF • SMALL • <input type="checkbox"/> MEDIUM • LARGE OFF • <input type="checkbox"/> RIGHT • CENTER <input type="checkbox"/> EXP • VRM <input type="checkbox"/> OFF • SMALL • LARGE <input type="checkbox"/> OFF • ON OFF • <input type="checkbox"/> ON <input type="checkbox"/> OFF • ON <input type="checkbox"/> OFF • ON <input type="checkbox"/> OFF • ON <input type="checkbox"/> OFF • ON <input type="checkbox"/> MARK • TIMER <input type="checkbox"/> LOWER • UPPER <input type="checkbox"/> AUTO • 1 • 2 • 5 • 10 • 20 • 50 • 100 <input type="checkbox"/> AUTO • FIXED <input type="checkbox"/> OFF • ON	<input type="checkbox"/> CF page 32-39

FUNCTION	FACTORY SETTING ( in the box )	USER SETTING MODE
<b>UNIT · ADJUST</b> DEPTH UNIT TEMP UNIT SPEED UNIT TEMP ADJ DRAFT	m · fm · br · ft ° C · ° F kt · km/h + 0.0 (- 9.9 ~ + 9.9) 00.0 ( 00.0 ~ 99.9)	<b>MODE SELECTION DIAL 6</b> <b>CF</b> page 40-42
<b>OTHERS</b> COLOR SET  OUTER DPTH MJR FREQ TRIGGER ECHO SIG OUTPUT TRANS RATE PULSE PANEL BRIGHT OPE. MODE SHIFT AR TEMP SENSOR ASHIFT LIMIT TRIG SYNC RANGE SET	A-1 · A-2 · B-1 · B-2 · C-1 · C-2 D-1 · D-2 · E-1 · E-2 OFF · ON LOW · HIGH INTRNL · EXTRNL INTRNL · EXTRNL OFF · 183N · 183T · 600S LOW · MEDIUM · HIGH NARROW · NORMAL · WIDE · 0.3(0.3 ~ 3.6) DARK · BRIGHT 0 · 1 1 · 5 · 10 · 50 · 100 OP-102 · OP-41 · NMEA-0183 999 (010 ~ 999) OFF · ON LINKED · SINGLE	<b>CF</b> page 43-51
<b>ALARM</b> SHALLOW DEEP FISH TEMP MAX. TEMP MIN. TEMP RANGE FISH ALARM	OFF · 0000 (0000 ~ 3999) OFF · 0000 (0000 ~ 3999) OFF · 6 (1 ~ 7) OFF · 35.0 (00.0 ~ 35.0) OFF · 00.0 (00.0 ~ 34.9) OFF · 00.0 (00.0 ~ 09.8) LOW · HIGH <span style="font-size: 2em; vertical-align: middle;">}</span> in case of °C	<b>CF</b> page 52-56
MAIN RANGE (NORMAL RANGE)	The range can be set freely. 1 ( 0 ~ 2 5 )	<b>MODE SELECTION DIAL 5</b>
SUB RANGE (EXPANSION RANGE)	1 (1)	<b>CF</b> page 19-20
FREQUENCY SELECTION DIAL MODE SELECTION DIAL OPERATION MODE PHASED RANGE AUTO RANGE AUTO SHIFT THRESHOLD PICTURE SPEED	1 (LOW FREQUENCY)  1 (NORMAL DISPLAY) NO SETTING 0 OFF OFF 7 COLORS PF1/1	<b>CONTROL PANEL</b>
USER SETTING	NO SETTING	<b>CF</b> page 16

## RETURN TO FACTORY SETTINGS

- ⊙ Ensure the power supply switch is turned off.  
Then while holding the  Mark key, press  ON key and keep pressing the  Mark key until the beep stops.  
After this operation all functions will then return to the factory setting.

## USER SETTINGS

- ⊙ In addition to the factory settings ES-7100 settings may also be set to functions selected by the user. This function is called USER SETTING. Range scales, gain control levels, color, power levels, etc. may be tailored by the user to fit his preference. The user may easily set the desired function settings by operating as explained below.
  - With this function the user may return to the desired function settings if the unit should become inoperable due to mistaken use of the controls. Please be sure to memorize user settings at the time the unit is first operated. Write down your user settings in case they are accidentally changed, or you wish to use different combinations for different fisheries. i.e. midwater vs. bottom.

### 1. MEMORIZE USER SETTINGS

- Set all functions and display units to the desired settings.  
Once all functions have been changed, press  OFF key to turn the power off.
- Next while pressing the  Memory read key, hold the  ON key to turn on the power and keep pressing the  Memory read key until the beep stops.
- After this operation all functions will be memorized under user setting.

### 2. RETURN TO USER SETTING

- In case of malfunction, turn the power off once.  
Next while pressing the  key, press  ON key to turn on the power.
- After this operation all functions will return to the user setting.

### 3. REVISE USER SETTING

- Reset all functions as required and then memorize the setting using the MEMORIZE USER SETTING procedure as above in 1.

### NOTE !

- 
- ⊙ If the  Mark key or the  Memory read key is released before the beep stops, they will not return to the user setting.
  - ⊙ Please note that the user setting will be canceled by doing the factory setting procedure.
-

## FUNCTION SETTINGS

This chapter provides you the explanation for function settings.  
Please set each function before using the ES-7100 to suit individual needs.

### RANGE SETTINGS

RANGE SET MENU	1. MAIN RANGE -----	19
	2. SUB RANGE -----	20

### FUNCTION SETTINGS

SETTING MENU -----		21
FUNCTION SET -----		21
	1. GAIN UP -----	22
	2. TVG -----	23
	3. D RANGE -----	24
	4. CLUTTER -----	24
	5. TX POWER -----	25

### REDUCTION

1. NTERFERENCE REDUCTION -----	26
2. JAMMING REDUCTION -----	27
3. NOISE REDUCTION -----	28
4. WHITE LINE -----	28

### SCREEN DIVISION

1. BOTTOM EXPANSION -----	29
2. SCREEN DIVISION -----	30
3. DUAL FREQUENCY -----	31
DISPLAY LOCATION	

<TO BE CONTINUED>

**DISPLAY ITEM  
SELECTION**

1. DEPTH DISPLAY SIZE -----	32
2. SCALE POSITION -----	33
3. EXPANSION/VRM -----	33
4. TEMPERATURE DISPLAY -----	34
5. TEMPERATURE GRAPH -----	34
6. COLOR SCALE -----	35
7. LATITUDE/LONGITUDE -----	35
8. SPEED DISPLAY -----	36
9. COURSE DISPLAY -----	36
10. VOLTAGE DISPLAY -----	37
11. MARK -----	37
12. DISPLAY POSITION -----	38
13. DEPTH GRID -----	38
14. PICTURE FEED -----	39
15. A-SCOPE -----	39

**UNIT • ADJUST**

1. DEPTH UNIT -----	40
2. TEMPERATURE UNIT -----	41
3. SPEED UNIT -----	41
4. TEMPERATURE ADJUSTMENT -----	42
5. DRAFT -----	42

**OTHERS**

1. COLOR SET -----	43
2. OUTER DEPT -----	45
3. MJR FREQ (PRIMARY FREQUENCY) -----	45
4. TRIGGER SIGNAL -----	45
5. ECHO SIGNAL -----	46
6. OUTPUT -----	46
7. TRANSMIT RATE -----	47
8. PULSE WIDTH -----	47
9. PANEL BRIGHTNESS -----	48
10. OPERATION MODE -----	49
11. SHIFT AVERAGE -----	49
12. TEMPERATURE SENSOR -----	49
13. AUTO SHIFT LIMIT -----	50
14. TRIGGER SYNCHRONIZATION -----	50
15. RANGE SET -----	51

**ALARMS**

1. SHALLOW -----	52
2. DEEP -----	53
3. FISH -----	54
4. TEMPERATURE MAX. -----	55
5. TEMPERATURE MIN. -----	55
6. TEMPERATURE RANGE -----	56
7. FISH ALARM -----	56

# RANGE SETTINGS

## RANGE SETTINGS

### 1. MAIN RANGE

☉ To customize the main ranges.

Example • Factory setting ranges:

m • fm • br :





NUMBER	RANGE
1 :	000 — 0025
2 :	000 — 0050
3 :	000 — 0100
4 :	000 — 0150
5 :	000 — 0200
6 :	000 — 0300
7 :	000 — 0500

ft :



NUMBER	RANGE
1 :	0000 — 0050
2 :	0000 — 0100
3 :	0000 — 0150
4 :	0000 — 0200
5 :	0000 — 0300
6 :	0000 — 0500
7 :	0000 — 1000



VARIABLE RANGES:  
up to 3000 (m, fm or br)  
up to 6000 feet

☉ Turn the Mode selection dial to "5" to display the menu below.

- Use the  or  EXP/VRM key to highlight the item to be set.
- Use the  or  Phased range key to set the desired range values.



RANGE SET MENU	
MAIN RANGE	
NUMBER	RANGE
1	000 — 0025
2	000 — 0050
3	000 — 0100
4	000 — 0150
5	000 — 0200
6	000 — 0300
7	000 — 0500

• Use the  or  EXP/VRM key  
to highlight the item you want to change.

• Use the  or  Phased range key  
to set the desired values.

 : makes the range larger.  
PHASED R.

 : makes the range smaller.

☉ Continuous pressing of the  PHASED R. or  PHASED R. key will change the range value faster.

☉ Use the  Memory read key to alternate Sub Range with Main Range .

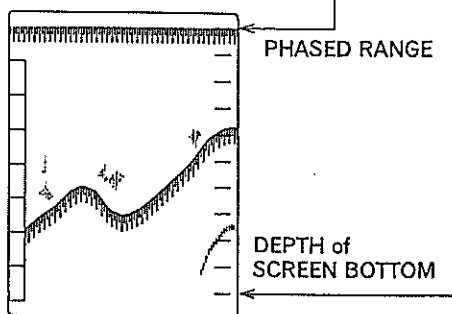

## 2. SUB RANGE

☉ To customize the sub ranges.



Example • Factory setting ranges:



m • f m • b r :				f t :						
NUMBER	RANGE				NUMBER	RANGE				
1:	0	0	0	1	1:	0	0	1	0	VARIABLE RANGES: up to 250 (m, fm or br) up to 500 feet
2:	0	0	0	2	2:	0	0	2	0	
3:	0	0	0	5	3:	0	0	3	0	
4:	0	0	1	0	4:	0	0	4	0	
5:	0	0	2	0	5:	0	0	5	0	
6:	0	0	3	0	6:	0	1	0	0	
7:	0	0	4	0	7:	0	2	5	0	
8:	0	0	5	0	8:	0	5	0	0	

☉ Turn the mode selection dial to “5” to display the RANGE SET MENU so that the MAIN RANGE and the SUB RANGE will appear on the screen.

• Use the  Memory read key to alternate Sub Range with Main Range .



RANGE SET MENU	
SUB RANGE	
NUMBER	RANGE
<b>1</b>	<b>0 0 0 1</b>
2	0 0 0 2
3	0 0 0 5
4	0 0 1 0
5	0 0 2 0
6	0 0 3 0
7	0 0 4 0
8	0 0 5 0

• Use the  or  EXP/VRM key to highlight the item you want to change.

• Use the  or  Phased range key to set the desired values.

 : makes the range larger.  
PHASED R.



 : makes the range smaller.



☉ Continuous pressing of the  PHASED R. or  PHASED R. Phased range key will change the range value faster.

# FUNCTION SETTINGS

## SETTING MENU

◎ Turn the mode selection dial to "6" to display the MAIN MENU below.

• Use the  or  EXP/VRM key to highlight the item to be set and the

 or  Phased range key to select the desired function setting.

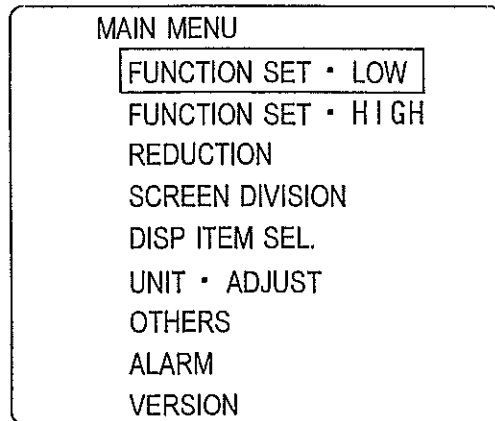



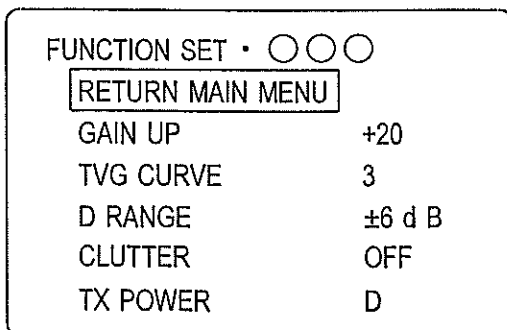

• After setting each function, memorize them by using "USER SETTING".

**CF** page 16.

## FUNCTION SETTINGS





• Use the  or  EXP/VRM key to highlight the item to be set.

• Use the  or  Phased range key to return to MAIN MENU.



# 1. GAIN UP

- ⊙ This function makes it possible to display a clearer picture of the full range and control sensitivity at various depths. **CF** page 65

GAIN UP + 20 Use the  or  Phased range key  
PHASED R.  
 to select the gain adjust level  
 (OFF → + 10 → + 20 → + 30 → + 40).

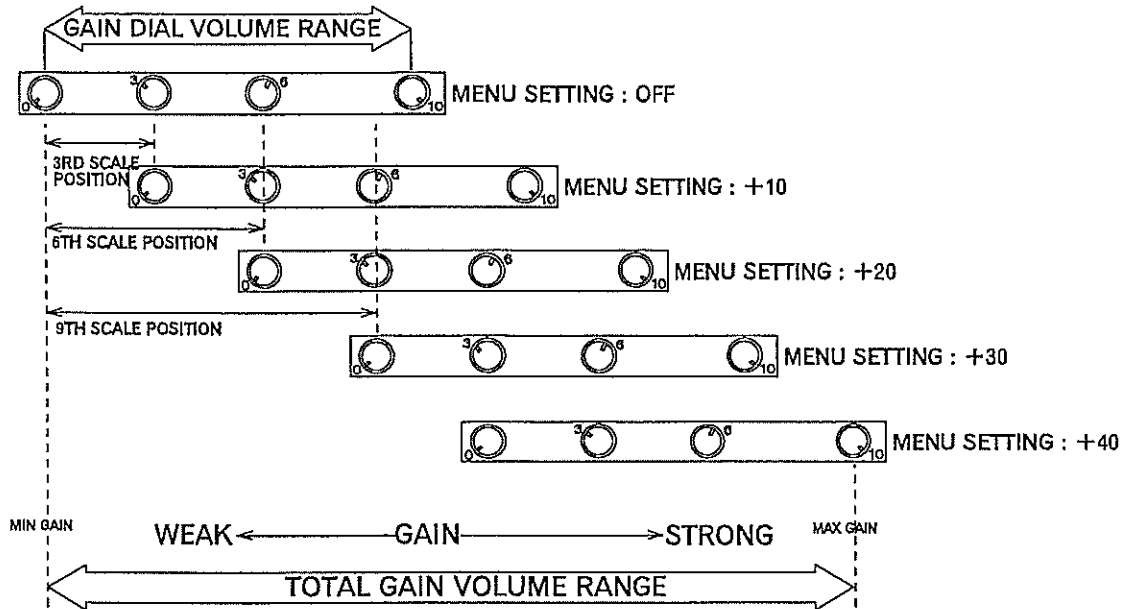



- When the menu gain adjust setting is changed from OFF to +10dB, the gain dial volume increases 3 points on the scale.
- When the menu gain adjust setting is OFF and the front panel dial is on 3, it has the same result as when the menu gain adjust setting is 10dB and the gain dial is on 0.

## NOTE !

- ⊙ The strong echoes may be displayed in some case without increasing the control panel gain dial, when the excessive gain adjust level is selected.

## 2. TVG

- ⊙ The TVG function may be adjusted according to the strength of the target echo.
- As the echoes returning from the bottom and from fish targets get weaker as the depth increases it is advantageous to have a Time Variable Gain that automatically compensates for the loss in signal strength.

TVG 3 ----- Use the  or  PHASED R. keys to select the TVG adjust level (1 → 2 → 3 → 4 → STC).

STC : STC function

- 1 : TVG CURVE ①
- 2 : TVG CURVE ②
- 3 : TVG CURVE ③
- 4 : TVG CURVE ④

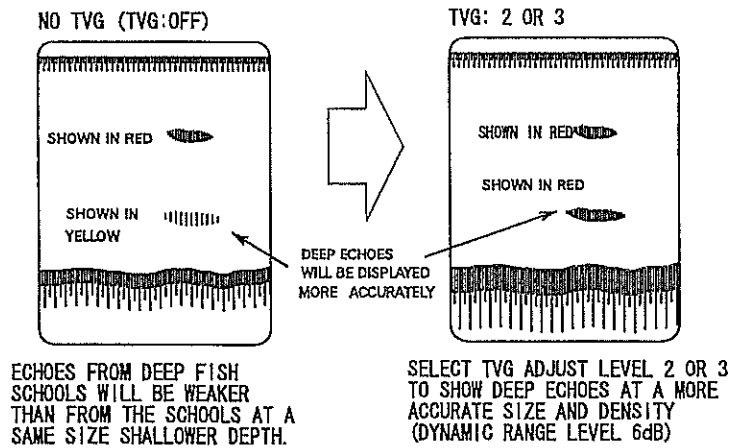
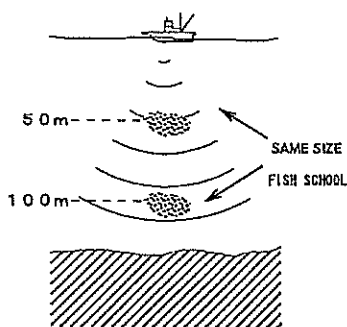
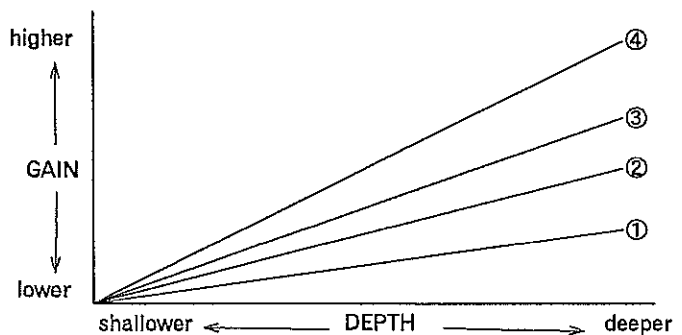

### NOTE !

- ⊙ Note the TVG function setting influences the far gain adjust and the gain adjust functions.

### 3. D RANGE (DYNAMIC RANGE)

- By shifting the dynamic range, the operator is able to discriminate more precisely the size, depth and density of the fish school.

Experimenting with this function will give you the best setting for various fishing operations.

D RANGE      ±6 d B

or

PHASED R.  
 Phased range key changes the dynamic range level  
 (±6dB, → + 5dB, → + 4dB, → + 3dB,  
 → - 3dB, → - 4dB, → - 5dB).

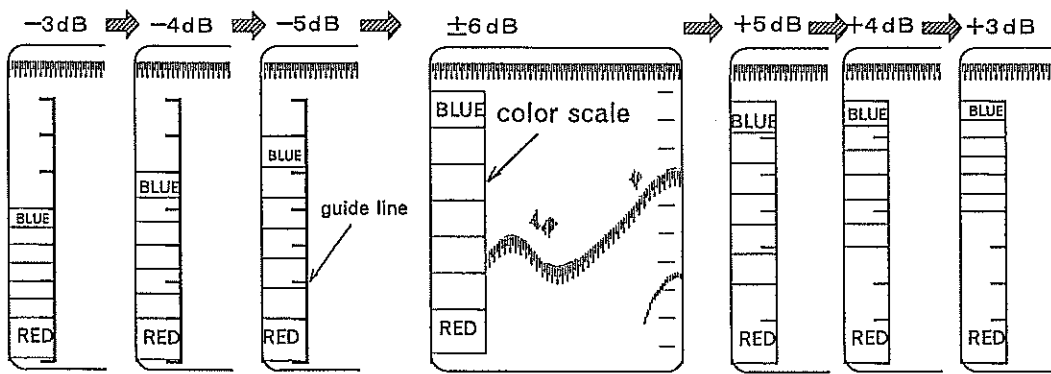

This diagram shows the comparative signal threshold levels to the standard ±6dB for the dynamic ranges.

When the dynamic range is changed from ±3dB to ±5dB, this range will be displayed in 7 colors.

### 4. CLUTTER

- By using this function the unwanted weak echo can be get rid of.

CLUTTER      OFF

or

PHASED R.  
 Phased range key changes the level to reduce clutter  
 (OFF → 1 → 2 → 3 → 4 → 5 →  
 6 → 7 → 8 → 9 → 10).

## 5. TX POWER

- © The output power of the ultrasonic soundwave may be selected.
  - In crowded fishing areas, this function may be used to reduce power and avoid interference to other Fishing boat's Sonars and Echo Sounders.
  - "D" indicates maximum power and then gradually reduced by moving from "C ", "B" to "A" which is minimum power.

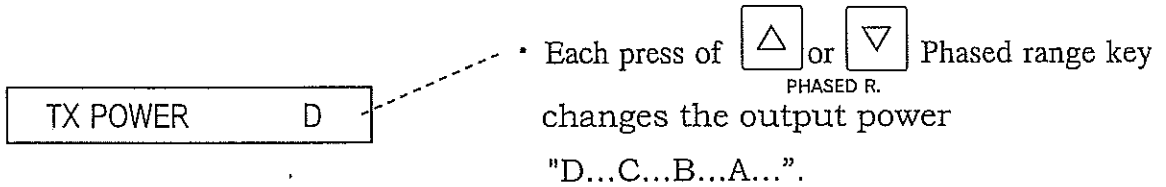



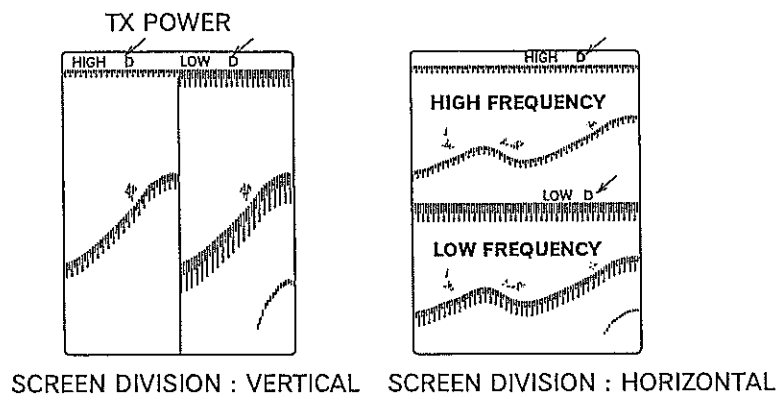

- The present level of TX POWER appears next to frequency as shown below.



# REDUCTION



REDUCTION	
RETURN MAIN MENU	
INTERF RED	OFF
JAMING RED	OFF
NOISE RED	OFF
WHITE LINE	OFF

- Use the  or  EXP/VRM key to highlight the item you want to change.
- Use the  or  PHASED R. key to set the desired values.

## 1. INTERFERENCE REDUCTION

☉ To reduce interference from nearby fishing vessels.

INTERF RED	OFF
------------	-----

- Each press of the  or  PHASED R. range key changes the level of reduction.  
(OFF → LOW → MIDDLE → HIGH)

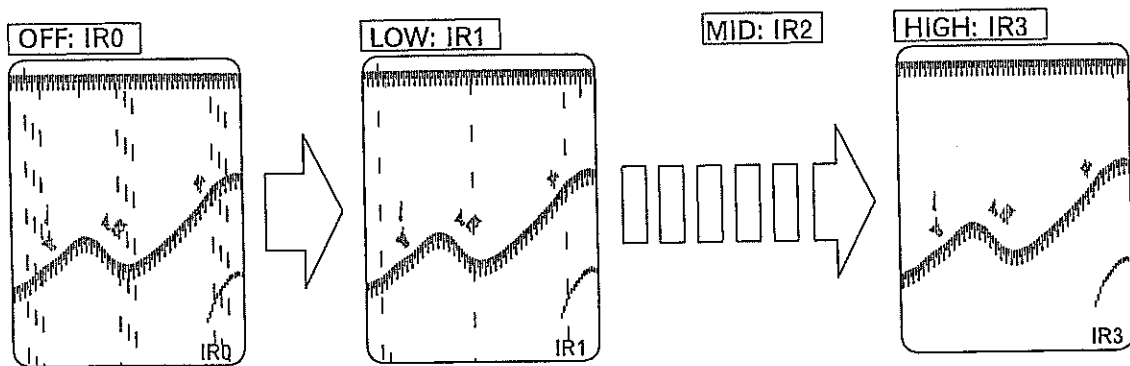

- OFF indicates no reducing function.
- As the level of the setting closes to HIGH, higher level of reduction is set and the level of reducing interference (IR0 → IR1 → IR2 → IR3) appears on the bottom screen.



- ☉ Some types of noise interference may not be reduced.
- ☉ Do not select excessive level than the level to be needed since the weak echoes are erased.

## 2. JAMMING REDUCTION

- ◎ The combined use of Interference reduction and Jamming reduction is effective in reducing noise due to jamming from other ships.

JAMING RED OFF ----- Each press of the  or  Phased range key changes the level. (OFF → 1.....→ 9)

- Off indicates no reducing function and the higher level it is set, the more irregular data appears like below.

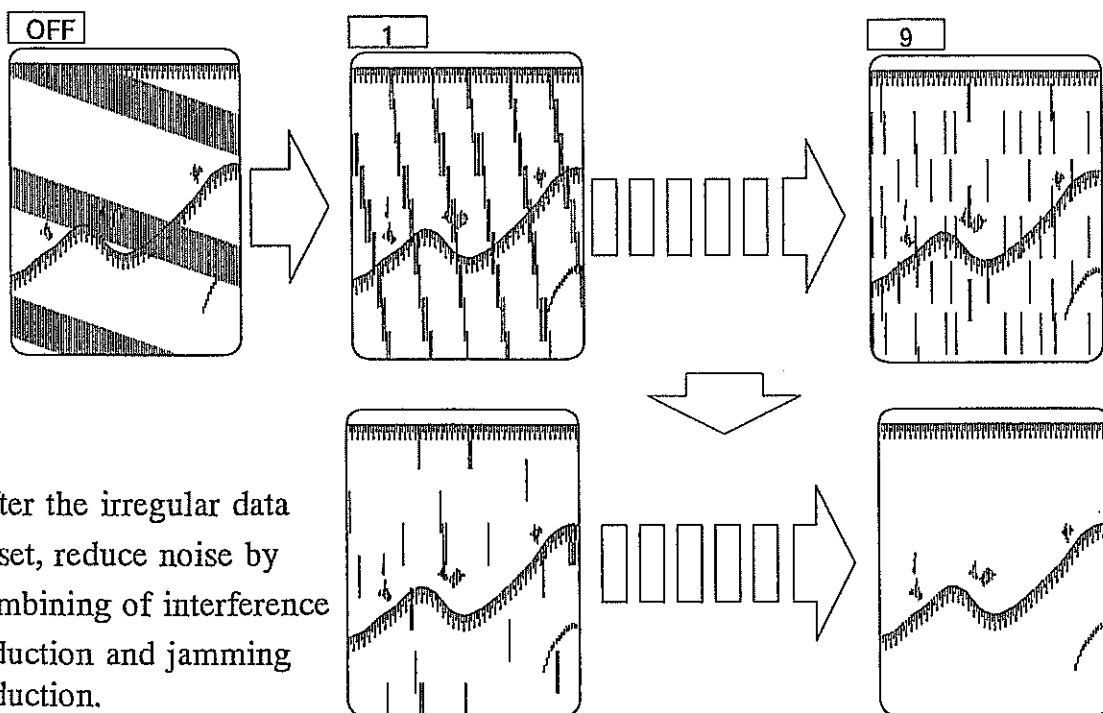

- After the irregular data is set, reduce noise by combining of interference reduction and jamming reduction.

### CAUTIONS



- ◎ Do not use INTERFERENCE RED combined with excessive level of JAMING RED, since the weak echoes are erased.
- ◎ Do not select an excessive level of INTERFERENCE RED., since the weak echoes are erased.

### WHAT IS "JAMMING"?

- ◎ By receiving sound waves from a neighboring ship's equipment of which frequencies are the same or similar, they influence each other and appear on the screen. Their change occasionally are seen doubled, up and down or the counter direction as Jamming.

### 3. NOISE REDUCTION

- ⊙ To reduce the noise cluttering the entire screen.

NOISE RED OFF ----- • Each press of the  or  PHASED R. Phased range key alternates OFF with ON.

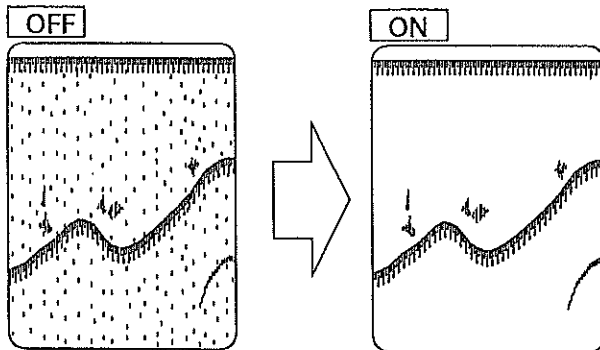

- OFF: The noise suppressing action is disabled.



- ⊙ Some noise reflections may not be reduced.

### 4. WHITE LINE

- ⊙ The function of the White Line is to help in discriminating the bottom and fish lying on or very close to the bottom.



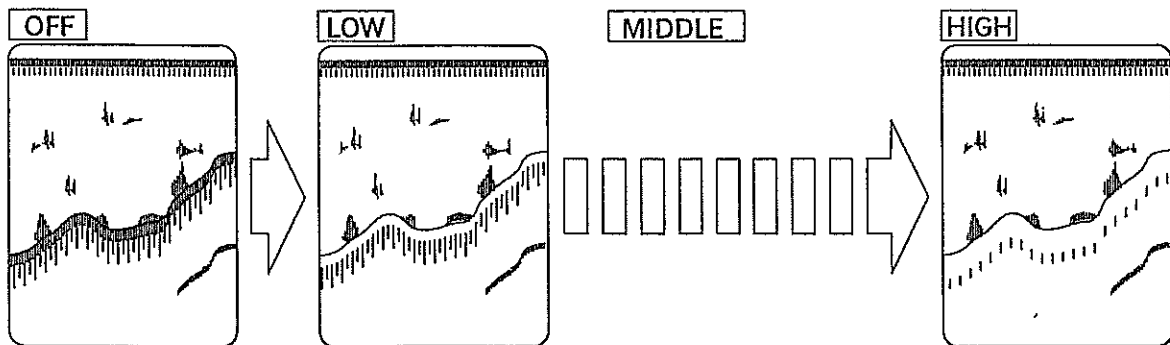

WHITE LINE OFF ----- • Each press of the  or  PHASED R. Phased range key changes the White Line control level. (OFF → LOW → MIDDLE → HIGH)

- OFF: The White Line control is disabled.

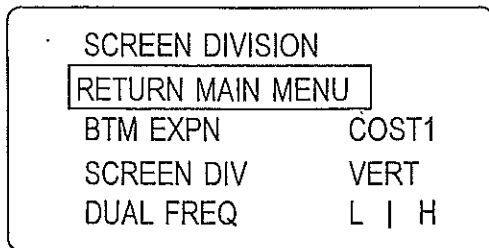

## SCREEN DIVISION



- Use the  or  EXP/VRM key to highlight the item you want to change.
- Use the  or  Phased range key to set the desired values.

### 1. BOTTOM EXPANSION

- ⊙ When you activate the Bottom Expansion Mode, as in the drawing in the next page, the areas of the bottom contour can be selected by the following shifts and displayed across the screen for close observation of the echoes of interest on or near of the bottom.

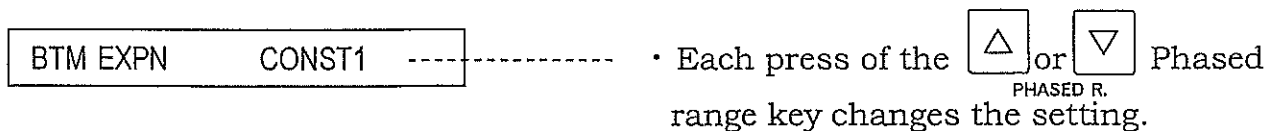

(CONST 1 → CONST 2 → CONST 3 → AUTO)

- CONST 1 : The upper part of the bottom is displayed with the expansion range.
- CONST 2 : Display position is shifted deeper than CONST 1.
- CONST 3 : Display position is shifted deeper than CONST 2.
- AUTO : To detect the bottom automatically with the bottom expansion range.



<TO BE CONTINUED>

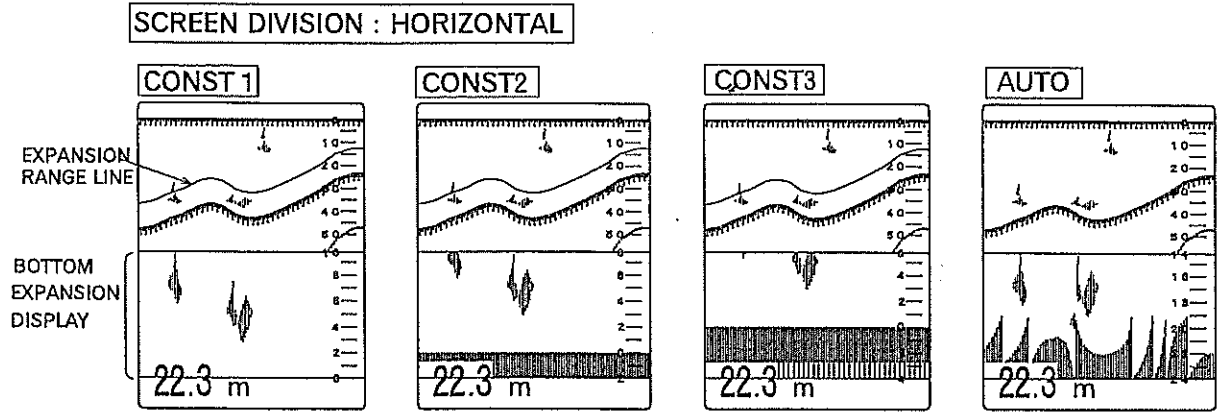



## 2. SCREEN DIVISION

◎ To select the screen division either VERTICAL or HORIZONTAL.

SCREEN DIV      HORIZ      ----- • Each press of the  or  PHASED R. range key alternates HORIZ with VERT.

- HORIZONTAL : displays the picture which is divided into horizontally. (upper/lower)
- VERTICAL : displays the picture which is divided into vertically. (left/right)

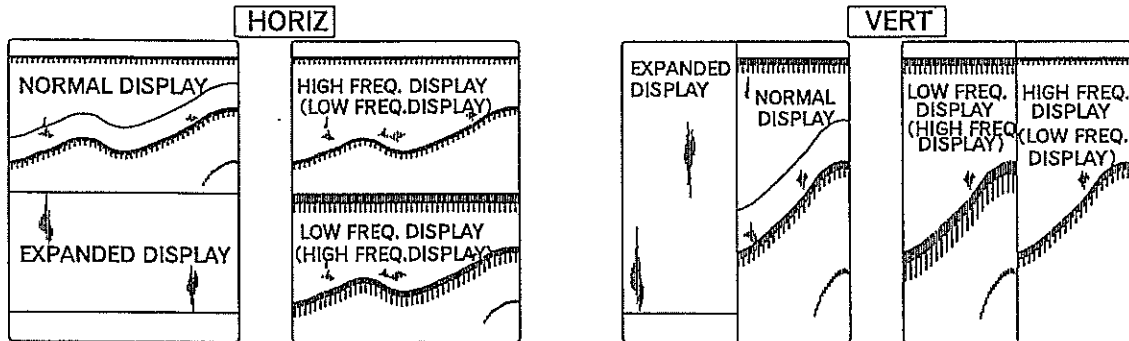

**EXAMPLES**

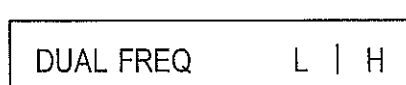

### 3. DUAL FREQUENCY DISPLAY LOCATION

⊙ Dual frequency display location is selected as shown the below drawings when Frequency Selection Dial "2" is activated.



Each press of the  or  PHASED R. Phased range key alternates in the following items.

When "VERT" (vertical) is selected, "L | H , H | L" will be displayed.

When "HORIZ" (horizontal) is selected, "H / L , L / H" will be displayed.

#### SCREEN DIVISION : VERTICAL

L | H : Left side; Low freq. Right side; High freq.  
 H | L : Left side; High freq. Right side; Low freq.

#### SCREEN DIVISION : HORIZONTAL

H / L : Upper half; High freq. Lower half; Low freq.  
 L / H : Upper half; Low freq. Lower half; High freq.

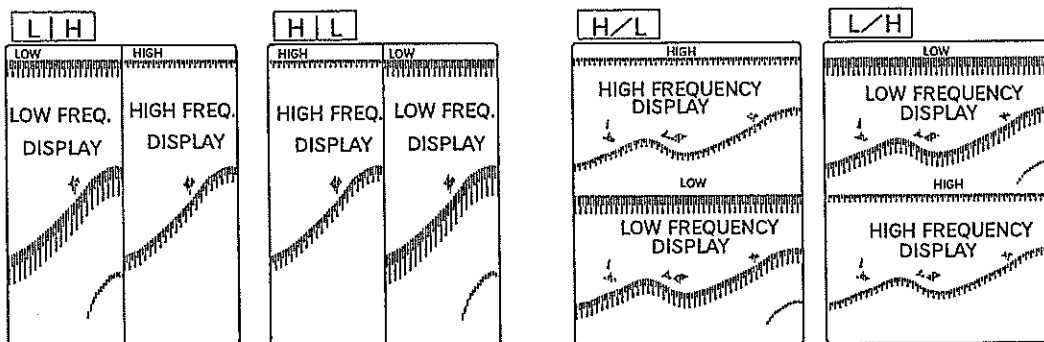





SCREEN DIVISION: VERTICAL

SCREEN DIVISION: HORIZONTAL

# DISPLAY ITEM SELECTION



DISP ITEM SEL.	
RETURN MAIN MENU	
DEPTH DISP	MEDIUM
SCALE POS.	RIGHT
EXP/VRM	EXP
TEMP DISP	OFF
TEMP GRAPH	OFF
COL. SCALE	ON
LAT.LONG.	OFF
SPEED DISP	OFF
COURSE	OFF
VOLT DISP	OFF
MARK	MARK
DISP.POS	LOWER
DEPTH GRID	AUTO
PICTURE FEED	AUTO
A-SCOPE	OFF

- Use the  or  EXP/VRM key to highlight the item you want to change.
- Use the  or  Phased range key to set the desired values.

## 1. DIGITAL DEPTH DISPLAY SIZE

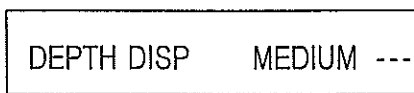
◎ To select the size of the digital display for depth.



• Each press of the  or  Phased range key

changes the size of digital

display for depth.

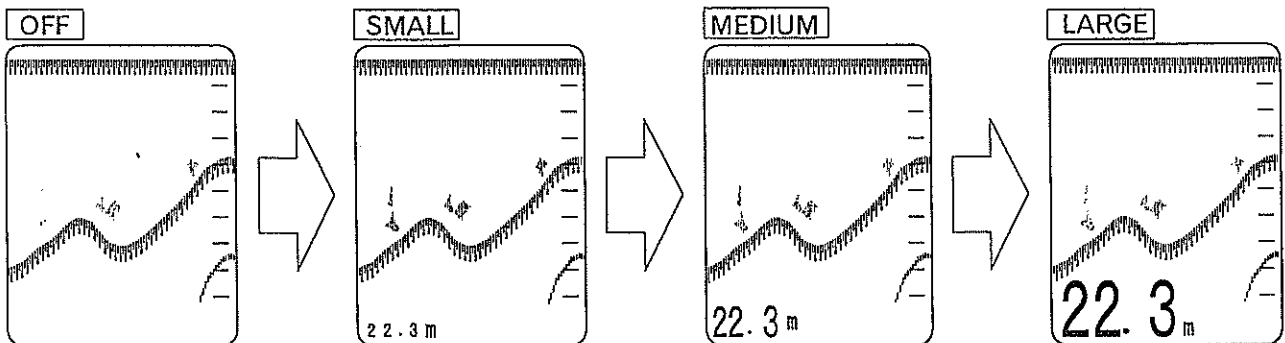

(OFF → SMALL → MEDIUM → LARGE)



## 2. SCALE POSITION

☉ To select the depth scale position.

SCALE                  RIGHT -----

Each press of the  or  PHASED R. Phased range key changes the Scale position display. (OFF → RIGHT → CENTER)

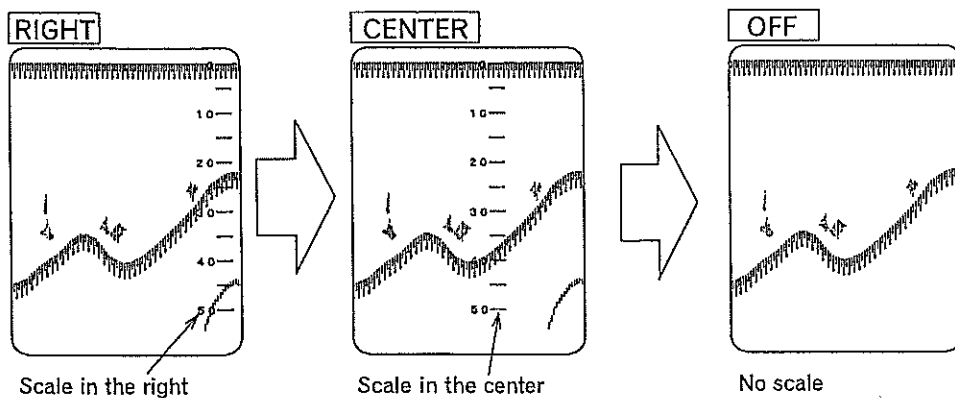

You can select the center or right of scale position display.



## 3. EXP/VRM (VRM EXPANSION)

☉ To activate the Expansion start point or the horizontal dotted line for digital depth on the screen.

EXP/VRM                  EXP -----

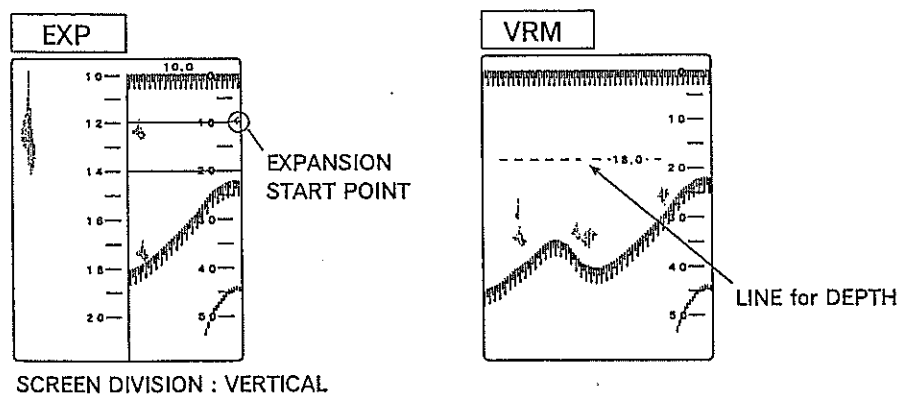

Each press of the  or  PHASED R. Phased range key alternates EXP with VRM. (EXP → VRM)

- EXP : activates the Expansion start point
- VRM : activates the Dotted line for digital depth



#### 4. TEMPERATURE DISPLAY SIZE

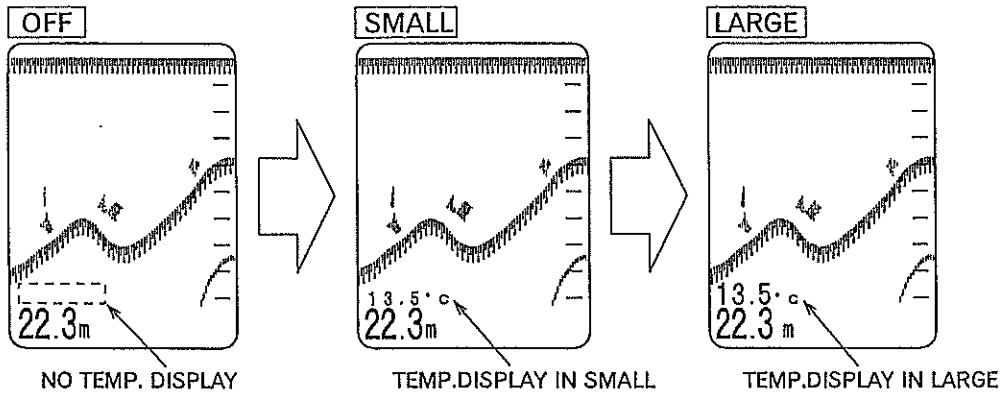

- ◎ To select the size of digital display for water temperature when an optional water temperature sensor is connected.

TEMP DISP OFF ----- • Each press of the  or  PHASED R. Phased range key alternates the size. (OFF → SMALL → MLARGE)



#### 5. TEMPERATURE GRAPH

- ◎ To select the display of the Temperature Graph either ON or OFF when an optional water temperature sensor is connected.

TEMP GRAPH OFF ----- • Each press of the  or  PHASED R. Phased range key alternates On with OFF.

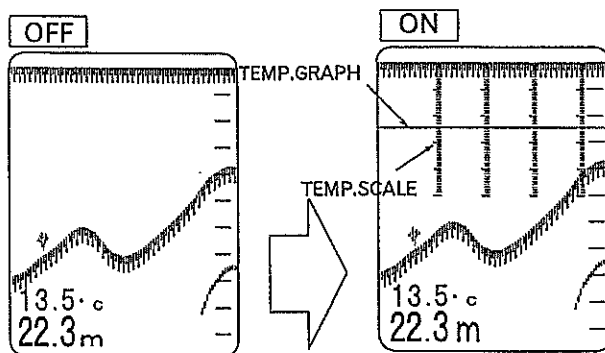



- ◎ To present a temperature will require that the ES-7100 is connected to an optional temp. sensor (OP-102 or OP-41) or via the NMEA-0183 input port.
- Please select OFF while disconnecting the temp.sensor.

## 6. COLOR SCALE

☉ To select Color Scale display either ON or OFF.

COL. SCALE ON

• Each press of the  or  PHASED R. range key alternates ON with OFF.

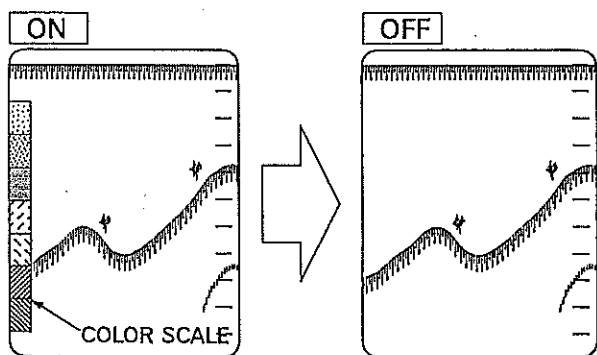



ON : Color Scale appears on the screen.  
OFF : Color scale disappears from the screen.

## 7. Ship's position in LATITUDE/LONGITUDE

☉ To present ship's position in the ES-7100 display will require that a navigator is connected via the NMEA (NMEA-0183) input port.

LAT.LONG. ON

• Each press of the  or  PHASED R. range key alternates On with OFF.

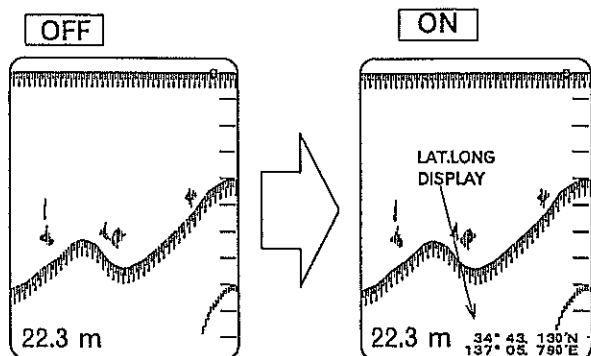

ON : Position in three decimals in minutes appears on the screen.  
OFF : Position (latitude/longitude) presentation disappears from the screen.

### NOTE !

The interface cable for NMEA-0183 input port is an option.

**CF** page 76/77

### 8. SPEED DISPLAY

☉ To present ship's speed in the ES-7100 display will require that a navigator is connected.

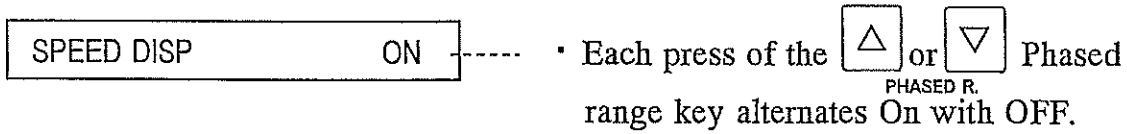

- ON : Speed presentation appears on the screen.
- OFF : Speed presentation disappears from the screen.

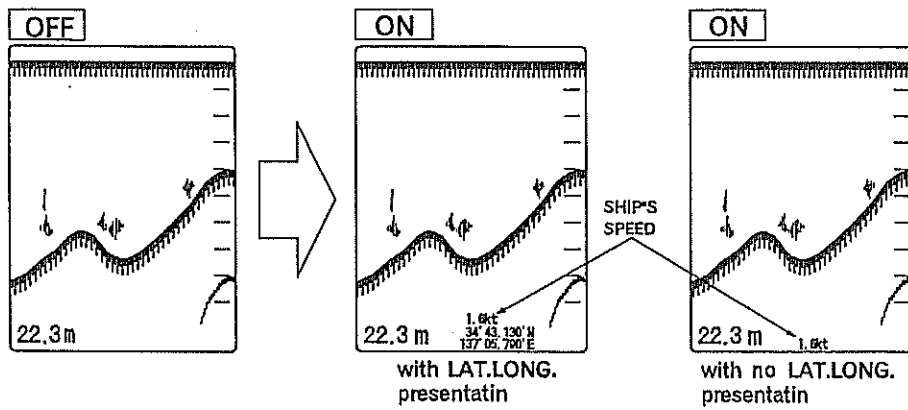

### 9. COURSE DISPLAY

☉ To present ship's course in the ES-7100 display will require that a navigator is connected.

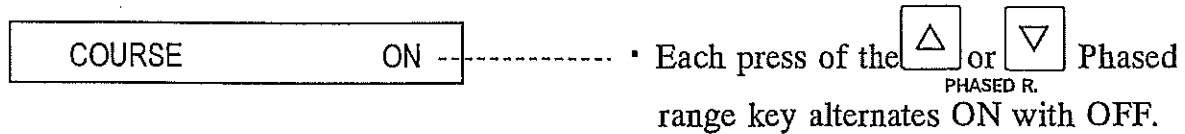

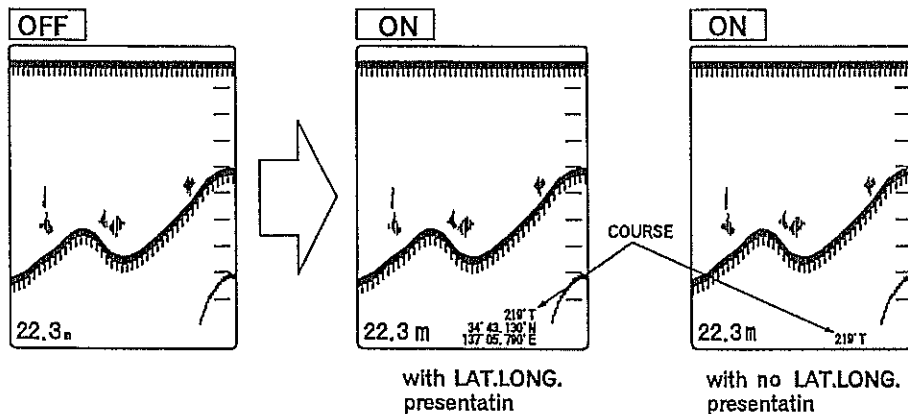

- ON : Course presentation appears on the screen.
- OFF : Course presentation disappears from the screen.

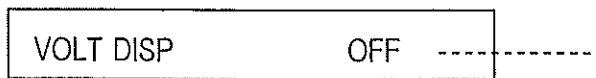

### 10. VOLTAGE DISPLAY

⊙ To present the voltage the ES-7100 uses.



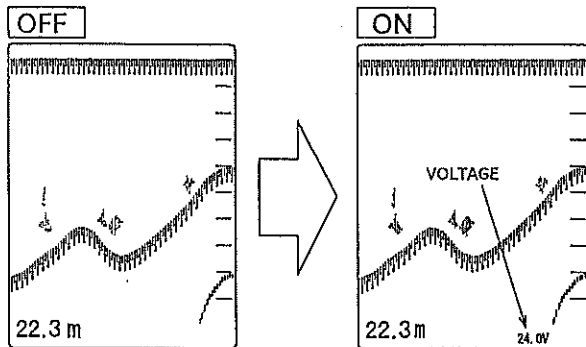

• Each press of the  or  PHASED R. Phased range key alternates ON with OFF.

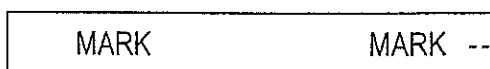

### 11. MARK

⊙ To place a vertical line on the screen for use as an echo mark.



• Each press of the  or  PHASED R. Phased range key alternates MARK with TIMER.

MARK : To place a vertical line on the screen.

TIMER : To time between the two lines.

⊙ Every time MARK key is pressed, the following procedure is performed.  
It displays a line and starts to time between two lines.

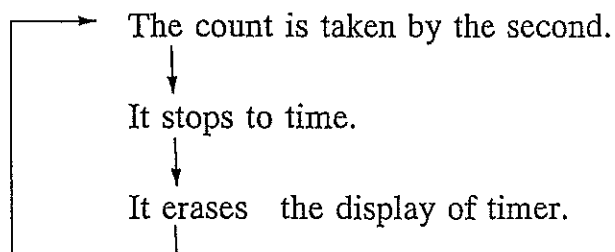

⊙ The maximum timing display is 60 minutes.

It starts to display from 1 second, after it times 60 minutes.



⊙ Timer stops and is erased when other function settings are changed.



## 12. DISPLAY POSITION for DEPTH and TEMPERATURE.

☉ To select the position for Depth and Temperature presentation on the screen.

DISP.POS                      LOWER

• Each press of the  or  PHASED R. Phased range key alternates LOWER with UPPER.

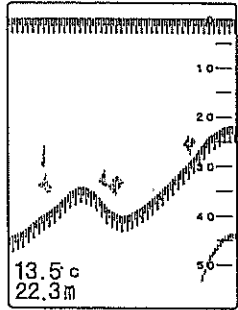

DIS. POSITION : LOWER



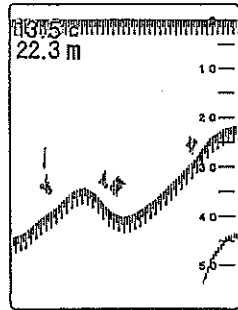

DIS. POSITION : UPPER



## 13. DEPTH GRID



☉ To adjust Depth scale unit with  or  PHASED R. Phased range key.

DEPTH GRID                      AUTO

• Each press of the  or  PHASED R. Phased range key change the value. (AUTO → 1 → 2 → 5 → 10 → 20 → 50 → 100)

### 14. PICTURE FEED

◎ You can select Picture feed control either AUTO or FIXED.



PICTURE FEED      AUTO ----- • Each press of the  or  PHASED R. range key alternates Picture feed control AUTO with FIXED.

"AUTO" : Picture moves to the left by the speed rate changes dependently of the range in use.

"FIXED" : Picture moves to the left by the speed rate independently of the range in use.  
The rate value is entered by Picture Speed key marked .

### 15. A-SCOPE

◎ The amplitude scope which appears in the right side of the echo display, can be turned on and off.

A-SCOPE      OFF ----- • Each press of the  or  PHASED R. range key alternates ON with OFF.

ON : A-Scope appears in the right side.  
OFF : A-Scope disappears from the screen.

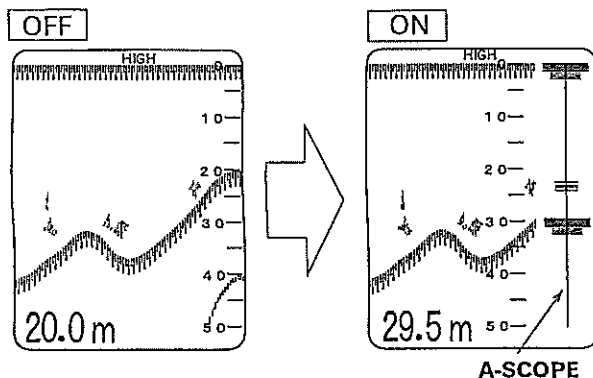

# UNIT ADJUSTMENT

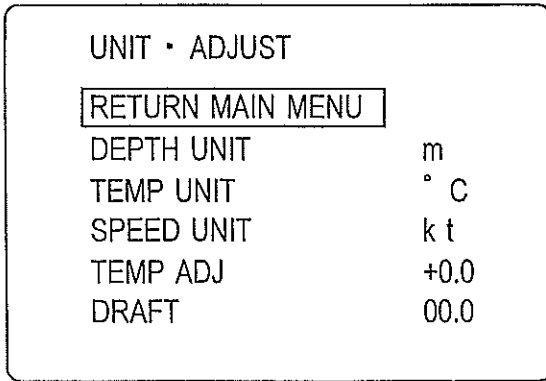

- Use the  $\Delta$  or  $\nabla$  EXP/VRM key to highlight the item you want to change.
- Use the  $\Delta$  or  $\nabla$  PHASED R. key to set the desired values

## 1. DEPTH UNIT

☉ The unit of depth may be selected.

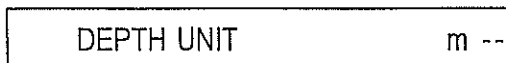

- Each press of the  $\Delta$  or  $\nabla$  PHASED R. key changes the depth unit. (m → br → fm → ft)

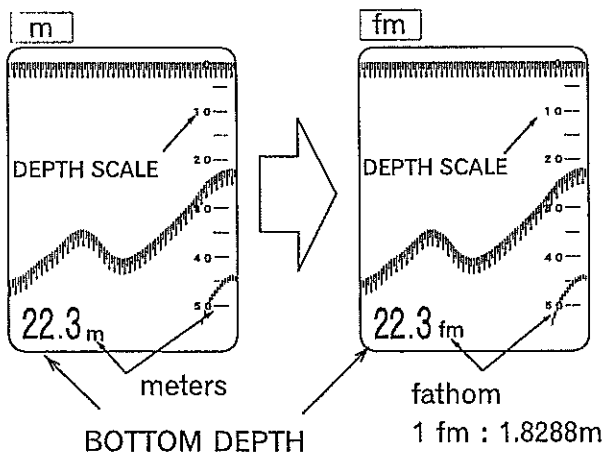



- m : To display the unit meters.
- fm : To display the unit fathom.  
1fm:1.8288m
- br : To display the unit braccia.  
1br:1.65m
- ft : To display the unit feet.  
1ft: 0.3048m

## 2. TEMPERATURE UNIT

- ⊙ To select the unit of Water temperature display and Water temperature graph.

TEMP UNIT      °C

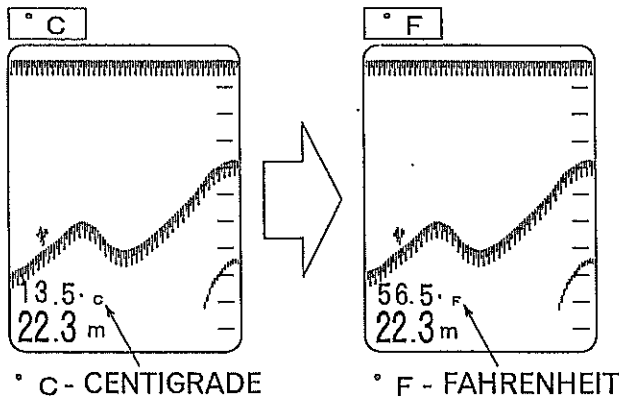

• Each press of the  or  PHASED R. range key alternates °C with °F.



## 3. SPEED UNIT

- ⊙ To select the unit of Speed unit.

SPEED UNIT      kt

• Each press of the  or  PHASED R. range key alternates kt with km/h.

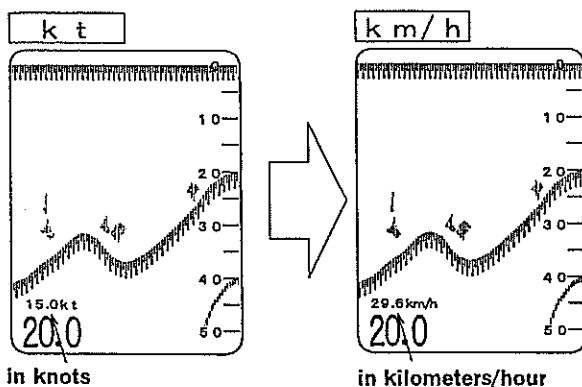



kt : Speed can be shown in knots.  
1kt=1.852km/h  
km/h : Speed can be shown in kilometers /hour.

### 4. TEMPERATURE ADJUSTMENT

☉ To adjust the water temperature displayed on the screen with an optional water temp. sensor connected.



• Every time the  or  PHASED R. key is pressed, it is adjusted by 0.1° in the range from - 9.9 to + 9.9.



- + 9. 9 : The maximum temperature adjustment
- ↑
- 0. 0 : No adjustment
- ↓
- 9. 9 : The minimum temperature adjustment

### 5. DRAFT

☉ The ES-7100 provides the draft height adjust control for displaying the depth readout from sea level. Usually, the ES-7100 shows up the depth readout from transducer surface to the bottom.

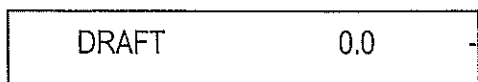
When your ship's draft height is 1 meter and actual depth from sea level is 5 meters, the display of depth readout is normally 4 meters. If necessary, you can change the difference by the following adjust.



• To enter the draft range value press the  or  PHASED R. key.

- 00.0 : Draft adjust is disabled.
- ⋮
- 99.9 : The maximum adjusted draft range

 PHASED R. : Every time this Phased range key is pressed, it increases the range by 0.1.



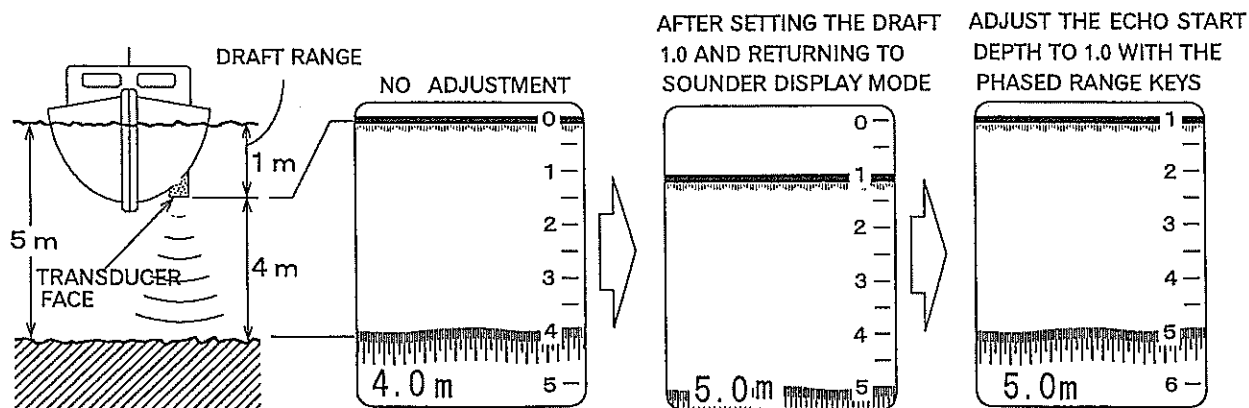

 PHASED R. : Every time this Phased range key is pressed, it decreases the range by 0.1.

**CF** Page 70



# OTHERS



OTHERS	
RETURN MAIN MENU	
COLOR SET	A-1
OUT.DPTH	OFF
MJR FREQ	LOW
TRIGGER	INTRNL
ECHO SIG	INTRNL
OUTPUT	OFF
TRANS RATE	MEDIUM
PULSE	NORMAL
PANEL BRIGHT	BRIGHT
OPE.MODE	0
SHIFT AR	1
TEMP SENSOR	OP-102
ASHFTLIMIT	999
TRIG SYNC	ON
RANGE SET	LINKED

- Use the  or  EXP/VRM key to highlight the item you want to change.
- Use the  or  Phased range key to set the desired values

## 1. COLOR SELECTION (COLOR PALETTE)

◎ The following basic color settings are available on the color select function.  
(A-1 · A-2 · B-1 · B-2 · C-1 · C-2 · D-1 · D-2 · E-1 · E-2)



COLOR SET	A-1
-----------	-----

• Each press of the  or  Phased range key changes the color setting.





- A-1 · A-2 · B-1 · B-2 · C-1 · C-2 · D-1 · D-2 : Set color options.
- E-1 · E-2 : Colors may be freely set.

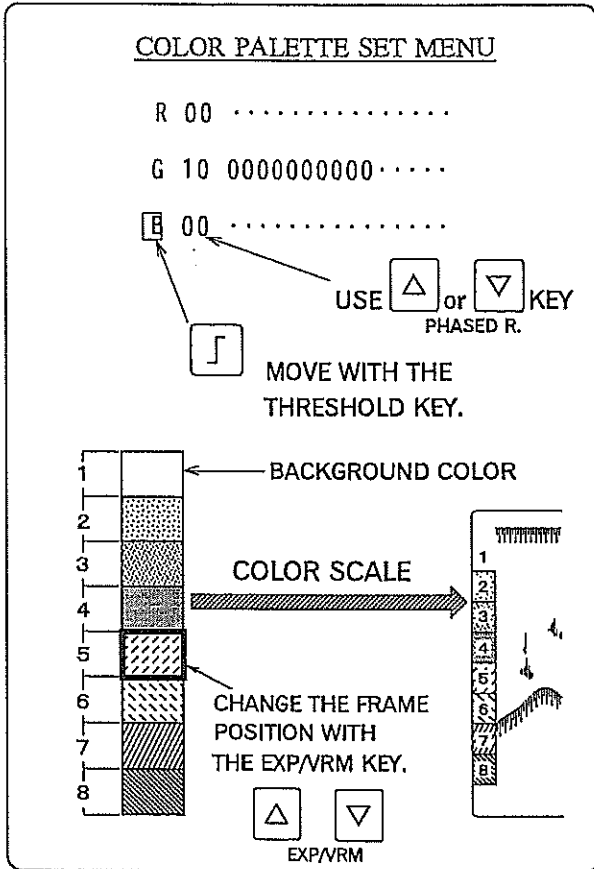

<TO BE CONTINUED>

### How to select the color

- ◎ To freely set the colors for E-1 and E-2, first highlight COLOR SET and specify E-1 or E-2 with the  or  Phased range key and press the  Threshold key to display the menu below.



- Use the  or  EXP/VRM key to move the frame to the level to be set. Each numeral color intensity (R: red, G: green, B: blue) will be displayed on the menu.
- Use the  Threshold key to highlight the color to be changed and select the color intensity (1: weakest ~ 15: strongest) with the  Phased range key.
- Once the color palette has been set, return to sounder display by using the Mode selection dial. The colors selected will be displayed on the screen and memorized under E1 or E2.

- Press either  or  key to return to MENU display.

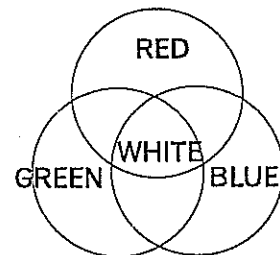

### WHAT IS "COLOR PALETTE"?

- ◎ There are three basic colors (red, green and blue). Each color has 15 intensity levels. By mixing the different colors and intensity levels the desired color tones may be created for the display.



## 2. OUTER DEPTH

- ☉ To display the bottom depth in digits by setting this function ON even if the bottom depth is out of the set range.



OUTER DPTH      OFF ----- • Each press of the  or  Phased  
PHASED R.  
 range key alternates ON with OFF.

OFF : No digit depth display in case the bottom depth is out of the range.

ON : The bottom depth is displayed at the bottom of the screen in digits even if the bottom depth is out of the set range.  
 However the processor in the ES-7100 automatically adjusts the transmit pulse rate "MEDIUM" to allow for the longer travel time to the bottom and return.



## 3. PRIMARY DEPTH MEASURING FREQUENCY for DIGITAL DISPLAY

- ☉ To select main frequency to measure the depth while performing dual frequency.

MJR FREQ      LOW ----- • Each press of the  or  Phased  
PHASED R.  
 range key alternates LOW with HIGH.

## 4. TRIGGER SIGNAL

- ☉ To select where the trigger signal is taken from, either INTRNL or EXTRNL. This function is used when using ES-7100 as a slave display to other sounding equipment.

TRIGGER      INTRNL ----- • Each press of the  or  Phased  
PHASED R.  
 range key alternates INTRNL with EXTRNL.



INTRNL : To select when using only the signal of the ES-7100

EXTRNL : To select when using the signal from the external unit.



## 5. ECHO SIGNAL

- ◎ To select where the echo signal is taken from, either INTRNL or EXTRNL.  
This function is used when using ES-7100 as a slave display to other sounding equipment.



ECHO SIG                      INTRNL ----- • Each press of the  or  PHASED R. range key alternates INTRNL with EXTRNL.

INTRNL    : To select when using only the signal of the ES-7100.

EXTRNL    : To select when using the signal from the external unit.

## 6. OUTPUT

- ◎ On installing optional kit serial output data is selected in the following sentences.

OUTPUT                      OFF ----- • By pressing the  or  PHASED R. range key the desired output sentence is selected from the followings.

- OFF            : No output
- 1 8 3 N       : To output data of DBT, TLL and MTW every 2 seconds.
- 1 8 3 T       : To output data of DBT every one second.
- 6 0 0 S       : To output data of depth at transfer rate of 600bps every one second.

### NOTE !

---

- ◎ DBT            : Depth below transducer.
  - ◎ TLL            : Latitude/Longitude when a navigator is connected.
  - ◎ MTW           : Water temperature when a temperature sensor is connected.
  - ◎ Data           : indicates the data transfer rate.  
transmitted rate
-

## 7. TRANSMIT RATE (PULSE REPETITION RATE)

⊙ The transmit rate of the sound waves from the transducer can be selected.

TRANS RATE      MEDIUM ----- • Each press of the △ or ▽ PHASED R. Phased range key changes the transmit rate.

HIGH : can be set the highest rate according to the range.

MEDIUM : can be set the standard rate according to the range.

LOW : can be reduced the standard rate by half.

## 8. PULSE WIDTH

⊙ The transmitted pulse width can be set.

- The transmitted pulse can be set to these three (narrow • normal • wide), where the optimum setting will be applied according to the range automatically. Or it can be set manually, if a specific pulse width (0.3 ~ 3.6 msec) is required.

- Select the optimum width of the transmitting pulse by ▽ or ■ key.

PULSE      NORMAL ----- • Each press of △ or ▽ PHASED R. Phased range key changes the setting.  
 (NARROW → NORMAL → WIDE → 0.3 ms)

- Use ▽ key to select the larger values.
- Use ■ key to select the smaller values.

<TO BE CONTINUED>

## FUNCTION SETTINGS

---

**NORMAL** : Setting **NORMAL** changes the value automatically according to the range. Refer to the list below.

**NARROW** : When the searching range is short and higher resolution is required, the pulse width should be set **NARROW**.  
Normal pulse width x 0.5

**WIDE** : The longer range gives less resolution.  
Normal pulse width x 1.5

**0.3** : The pulse width is independently of the range in use and its initial value of the pulse width is 0.3 msec. The pulse width is to be set every 0.05 msec unit from 0.3 to 3.6 msec.

RANGE DEPTH (m)	PULSE (msec)
0 ~ 40	0.3
~ 80	0.6
~ 240	1.2
~ 640	2.4
641 ~	3.6

### NOTE !

~~~~~  
⊙ In actual practice, the short pulse width gives better resolution, and less noise in shallow water. A long pulse will reach deeper but give less resolution.  
~~~~~

## 9. PANEL BRIGHTNESS

⊙ To select the level of brightness.

PANEL BRIGHT      MEDIUM

Each press of the  or  Phased  
PHASED R.  
range key alternates DARK with BRIGHT.

## 10. OPERATION MODE

- ◎ To select one of the Operation modes that was stored in the memory.

OPE. MODE            0 ----- · Each press of the △ or ▽ PHASED R. Phased  
 range key alternates 0 with 1.

- Each of the setting 0 and 1 can store 3 kinds of operation mode you have created, that is, in total 6 kinds of operation mode can be stored in the memory.

## 11. SHIFT AVERAGE - Scale increment

- ◎ A different shift can be set for the display in the depth range.

SHIFT AR            1 ----- · Each press of the △ or ▽ PHASED R. Phased  
 range key changes the value.  
 (1 - 5 - 10 - 50 -100)

- For example in the SHIFT AR 1, the depth on the screen moves by 1 depth unit and in the SHIFT AR 5 does by 5 depth unit.

## 12. TEMPERATURE SENSOR

- ◎ To select one of the interfacing connections for temperature sensor.



TEMP SENSOR        OP-102 ----- · Each press of the △ or ▽ PHASED R. Phased  
 range key changes the item.  
 (OP-102 → OP-41 → NMEA-0183)

- To present a temperature via the NMEA-0183 input port, the NMEA IN terminal kit (OP-305) is required.

### 13. AUTO SHIFT LIMIT

◎ To select the upper limit of the depth value for automatic bottom tracking.



ASHIFT LIMIT	999
--------------	-----

· Each press of the  or  Phased range key changes the depth value between 010 and 999 by 1 unit.  
For AUTO SHIFT info. **CF** Page 71

### 14. TRIGGER SYNCHRONIZATION

◎ To select the high/low frequency sound wave transmitting simultaneously or separately.

TRIG SYNC	ON
-----------	----

· Each press of the  or  Phased range key alternates ON with OFF.

- ON : transmits the high/low frequency sound waves at the same speeds and synchronizes the transmit cycle for deep range.
- OFF : transmits the high/low frequency sound waves separately and is the same use in the single frequency mode.

In this case it sometimes generate interference that degrades the sounder's performance.

### 15. RANGE SET

⊙ To activate the various functions regardless of each frequency.

• In case of LINKED the following items will be functioned under the same settings.

- RANGE (NORMAL MODE)
- SHIFT (UPPER DEPTH)
- SUB RANGE (EXPANSION MODE)
- AUTO RANGE
- AUTO SHIFT
- PICTURE SPEED
- INTERFERENCE REDUCTION
- JAMMING REDUCTION
- NOISE REDUCTION

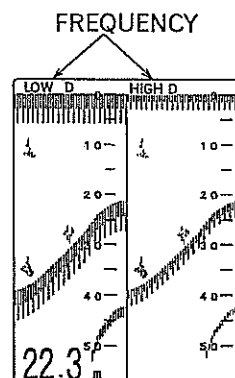

• In case of SINGLE the above items will be usable in the settings differently in each frequency. Selecting SINGLE, the one of the frequencies displayed on the upper screen will be highlighted.

Note that both HIGH and LOW will not highlighted in case of LINKED.



• Each press of the  or  PHASED R. Phased range

key alternates LINKED with SINGLE.

 • By pressing this key "HIGH" on the top of the screen is highlighted and enables the settings for high frequency presentation to change. While activating this key, the settings in the low frequency on the screen are unable to be changed.

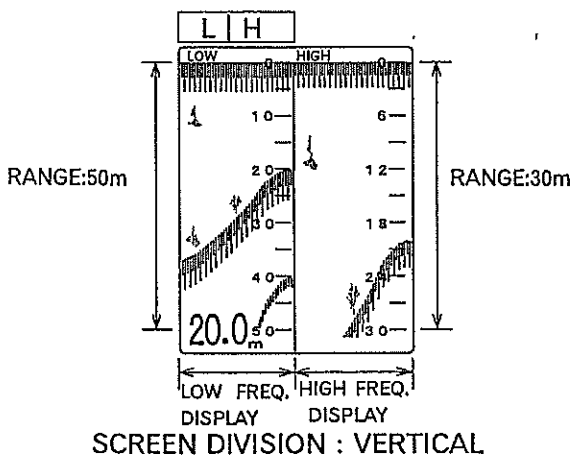

 • By pressing this key "LOW" on the top of the screen is highlighted and enables the settings for low frequency presentation to change.





• As shown left the different range in each frequency is functioned simultaneously.

# ALARMS

ALARM	
RETURN MAIN MENU	
SHALLOW	OFF
DEEP	OFF
FISH	OFF
TEMP MAX.	OFF
TEMP MIN.	OFF
TEMP RANGE	OFF
FISH ALARM	LOW



• Use the  or  EXP/VRM key to highlight the item you want to change.



• Use the  or  Phased range key to set the desired values

## 1. SHALLOW ALARM

☉ To set to sound a "beep" if the echo sounder detects the sea bottom above (shallower than) the set alarm depth.

SHALLOW	OFF
---------	-----

• Each press of the  or  Phased range key alternates OFF with 0000.

• To access the alarm setting and set the value from "0000" into the desired alarm depth value by pressing the  or  key.

The active zone is indicated by a Shallow maker on the right side of the screen.

 key : increases the value. (The position of the marker is deeper.)

 key : decreases the value. (The position of the marker is shallower.)

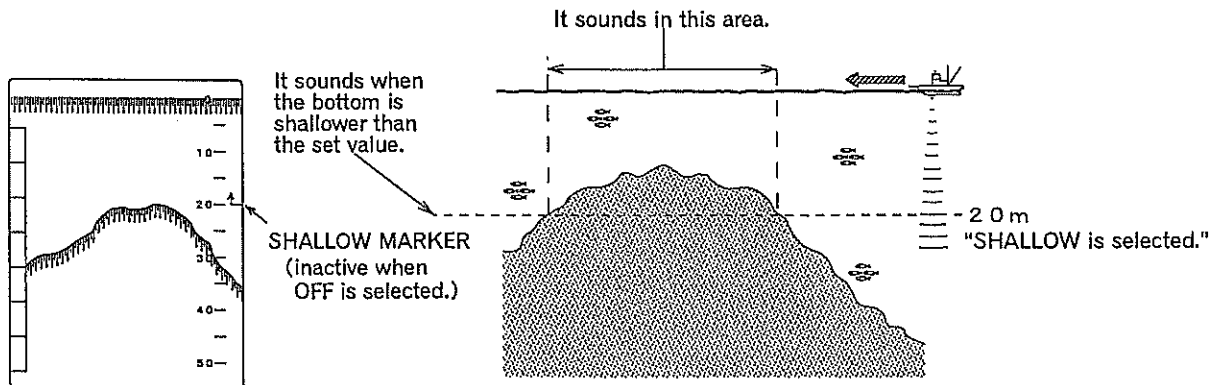



☉ Select "OFF" in case of not utilizing the alarm functions.

Refer to the next page for the way of inactivating this function.

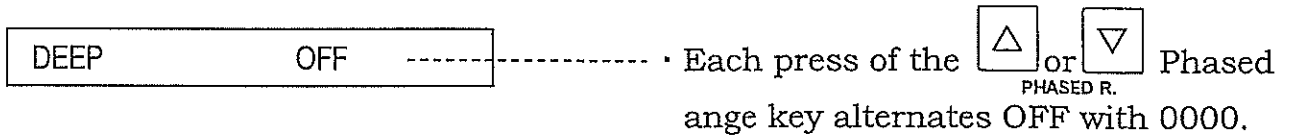

## 2. DEEP ALARM

- ⊙ To set to sound a "beep" if the echo sounder detects the sea bottom below (deeper than) the set alarm depth.



- To access the alarm setting and set the value from "0000" into the desired alarm depth value by pressing the  or  key.

The active zone is indicated by a Deep maker on the right side of the screen.

-  key : increases the value. (The position of the marker is deeper.)
-  key : decreases the value. (The position of the marker is shallower.)

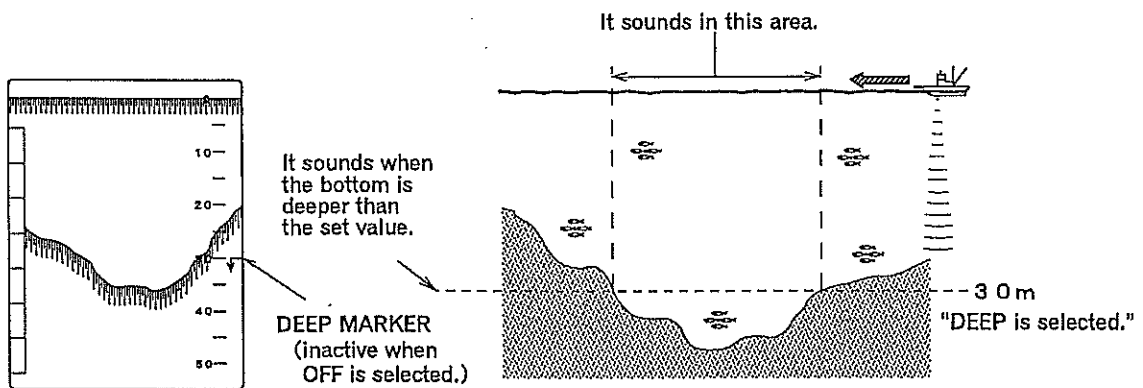

- ⊙ Select "OFF" in case of not utilizing the alarm functions.

### How to Inactivate the Alarms

- ⊙ Once the alarm starts to sound, press any key to disable the alarm.

Pressing any key will silence the alarm and will not cause a menu change.





### 3. FISH ALARM



- ⊙ The Fish alarm mode will alert you if any object appears between the two set points (Deep alarm and Shallow alarm).

This sets the level of the alarm sounding.



• Each press of the  or  PHASED R. range key alternates OFF with 6.

• The desired level can be selected

by pressing the  or  key after entering 6 (initial value).

OFF : disable Fish alarm

1 : color scale 1-7

2 : color scale 2-7

3 : color scale 3-7

4 : color scale 4-7

5 : color scale 5-7

6 : color scale 6-7

7 : sounds in relation to color scale No.7

The alarm sounds in relation to the color scale No.

 key : increases the value.

 key : decreases the value.

FOR EXAMPLE:

set value - color scale 3

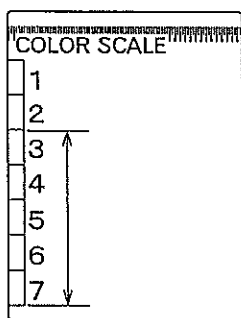

It sounds if the responded color level is more than the set value.

It sounds in these areas.

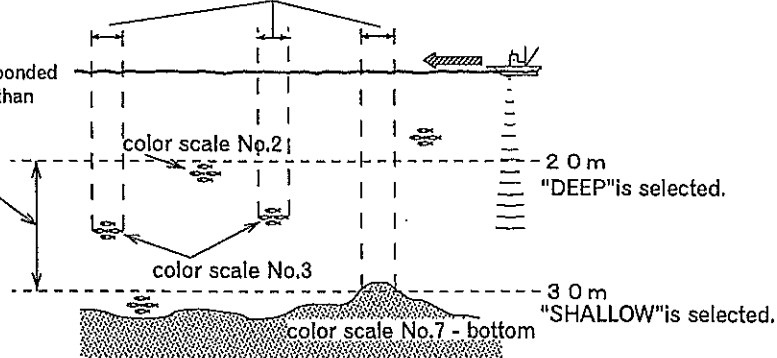

- ⊙ To operate Fish alarm turn both Shallow alarm and Deep alarm OFF after setting both desired alarm depth.



- ⊙ Select "OFF" in case of not utilizing the alarm functions.



Refer to the previous page for the way of inactivating this function.



#### 4. TEMPERATURE MAXIMUM ALARM

- ⊙ The alarm will sound when the water temperature goes above the set degree that can be set from 0.0 to 35.0 by 0.1 unit (°C) in this case.

An optional temp. sensor is required to activate TEMP MAX alarm.

TEMP MAX OFF ----- · Each press of the  or  Phased  
PHASED R.  
 range key alternates OFF with 35.0.

- The desired value can be selected by pressing the  or  key.



after entering 35.0 (initial value).  key : increases the value.  
 key : decreases the value.



- ⊙ Select "OFF" in case of not utilizing the alarm functions.



#### 5. TEMPERATURE MINIMUM ALARM

- ⊙ The alarm will sound when the water temperature goes below the set degree that can be set from 0.0 to 34.9 by 0.1 unit (°C) in this case.

An optional temp. sensor is required to activate TEMP MIN. alarm.

TEMP MIN. OFF ----- · Each press of the  or  Phased  
PHASED R.  
 range key alternates OFF with 00.0.

- The desired level can be selected by pressing the  or  key.

after entering 00.0 (initial value).  key : increases the value.  
 key : decreases the value.



- ⊙ Select "OFF" in case of not utilizing the alarm functions.



**Refer to the next page for the way of inactivating this function.**

## 6. TEMPERATURE RANGE ALARM



- ⊙ The alarm will sound when the water temperature goes above the set degree the defined changed value compared to the change of the last 1 minute, ranging from 00.0 to 09.8 by 0.1 unit (°C) in this case.

An optional temp. sensor is required to activate TEMP RANGE alarm.

TEMP RANGE. OFF ----- · Each press of the  or  Phased  
PHASED R.  
 range key alternates OFF with 00.0.

- The desired level can be selected by pressing the  or  key.

after entering 00.0 (initial value).

 key : increases the value.  
 key : decreases the value.

- ⊙ Select "OFF" in case of not utilizing the alarm functions.



### How to Inactivate the Alarms

- ⊙ Once the alarm starts to sound, press any key to disable the alarm.

Pressing any key will silence the alarm and will not cause a menu change.

## 7. FISH ALARM FREQUENCY

- ⊙ To select frequency on sounding the Fish alarm.

TEMP RANGE OFF ----- · Each press of the  or  Phased  
PHASED R.  
 range key alternates LOW with HIGH.

## FRONT CONTROL PANEL OPERATION

This chapter explains how to operate the front control panel of the ES-7100 Echo sounder.

DISPLAY MODES	-----	58
DIAL OPERATION	FREQUENCY SELECTION DIAL	----- 59
	MODE SELECTION DIAL	----- 60
	1. NORMAL MODE	----- 61
	2. BOTTOM EXPANSION MODE	----- 61
	3. PARTIAL EXPANSION MODE	----- 62
	4. NAVIGATION DISPLAY MODE	----- 62
	5. RANGE SETTINGS	----- 63
	6. MAIN MENU	----- 63
	BRIGHTNESS DIAL	----- 64
	GAIN DIAL	----- 65
	FAR GAIN DIAL	----- 66
	1. TVG	----- 66
	2. STC	----- 67
KEY OPERATION	OPERATION MODE	----- 68
	MEMORY WRITE / READ KEY	----- 68
	EXP/VRM KEY	----- 69
	1. EXPANSION START POINT	----- 69
	2. VRM LINE	----- 69
	RANGE KEY	----- 70
	PHASED RANGE KEY	----- 70
	AUTO RANGE	----- 71
	AUTO SHIFT	----- 71
	PICTURE SPEED KEY	----- 72
	MARK KEY	----- 73
	1. MARK	----- 73
	2. TIMER	----- 73
	THRESHOLD KEY	----- 74
	HIGH/LOW FREQUENCY KEY	----- 74
	EXPANSION RANGE KEY	----- 75









# DISPLAY MODES

## DISPLAY MODES

◎ The ES-7100 can display the data in a number of different ways.

Depending on your requirements you can select one using Mode selection dial, Frequency selection dial and the menu system.

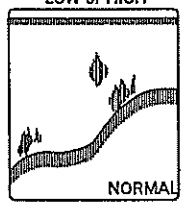
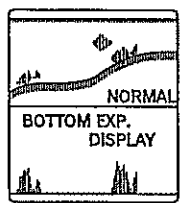
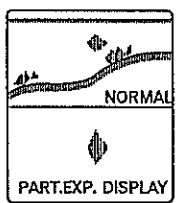
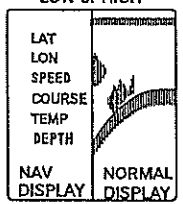
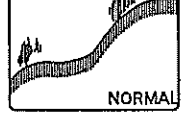
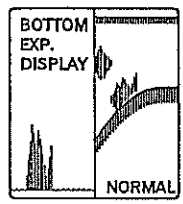
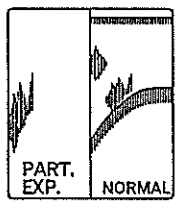
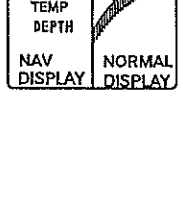
Following is a description of each of the modes available.

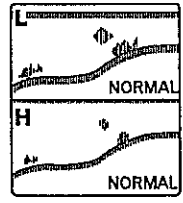
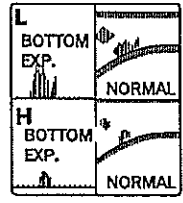
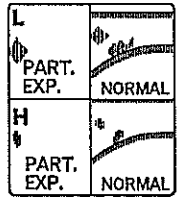
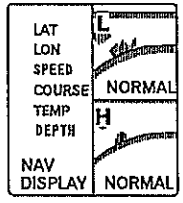
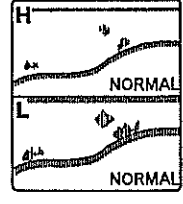
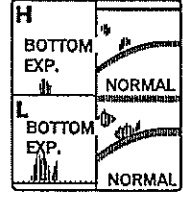
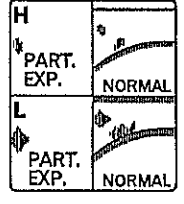
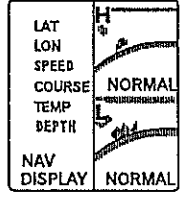
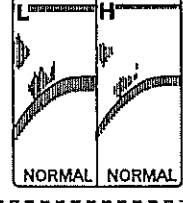
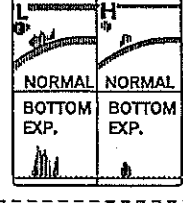
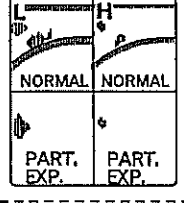
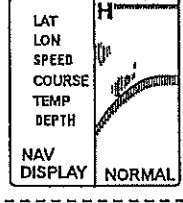
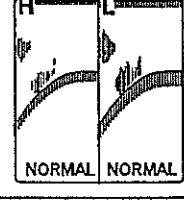
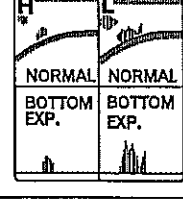
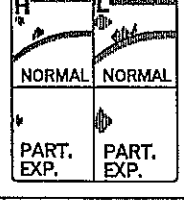
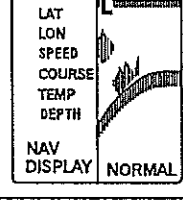
MODE SELECTION		   				
		NOORMAL DISPLAY	NORMAL/BOTTOM EXPANSION DISPLAY	NORMAL/PARTIAL EXPANSION DISPLAY	NORMAL/NAVIGATION DISPLAY	
FREQ. SELECT. DIAL	SCREEN DIVISION					
	<b>SINGLE FREQUENCY</b>  (LOW) OR  (HIGH)	HORIZ	LOW or HIGH 			LOW or HIGH 
VERT						
<b>DUAL FREQUENCY</b> 	HORIZ	L/H				
		H/L				
	VERT	L   H				
		H   L				

L : LOW FREQUENCY H: HIGH FREQUENCY  
 NORMAL : NORMAL DISPLAY  
 NAV. : NAVIGATION DISPLAY

PART. EXP. : PARTIAL EXPANSION DISPLAY  
 BOTTOM EXP. : BOTTOM EXPANSION DISPLAY

## FREQUENCY SELECTION DIAL

- ⊙ Depending on your requirements you can select one of the following combination screen using Frequency selection dial.

Following is a description of each of the modes available and the actual displays are relevant to the settings of the menu system and Mode selection dial.

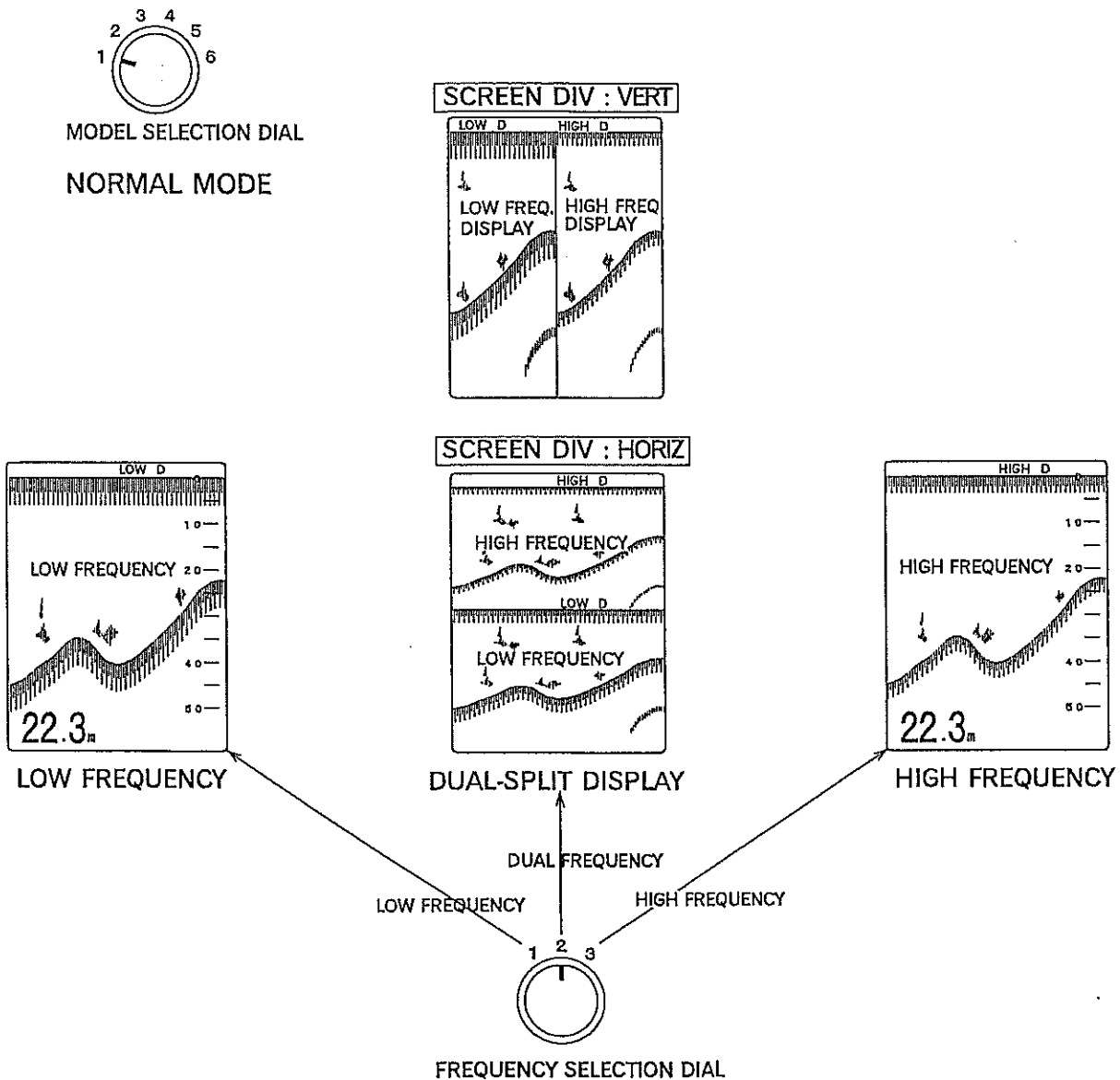

- Refer to the Display Modes in page 58 for the combination screens.

# MODE SELECTION DIAL

⊙ Depending on your requirements you can select one using Mode selection dial.

Following is a description of each of the modes available and the actual displays are relevant to the settings of the menu system and Frequency selection dial.

SCREEN DIV : VERT

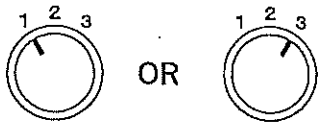

OR

LOW FREQUENCY or HIGH FREQUENCY

FREQUENCY SELECTION DIAL

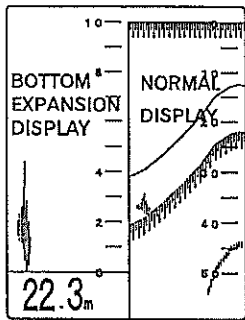

NORMAL + BOTTOM EXPANSION SPLIT DISPLAY

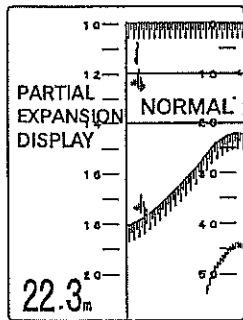

NORMAL + PARTIAL EXPANSION SPLIT DISPLAY

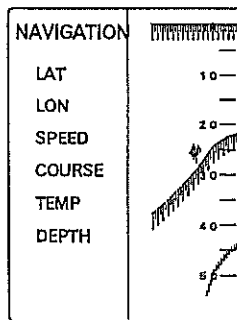

NORMAL + NAVIGATION SPLIT DISPLAY

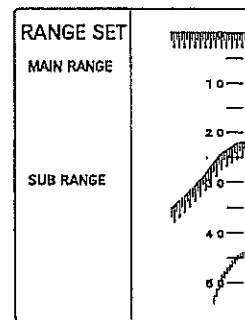

RANGE SETTINGS

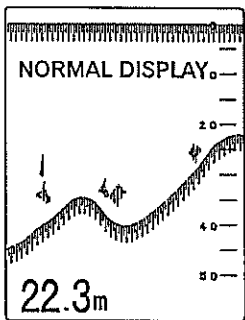

NORMAL DISPLAY

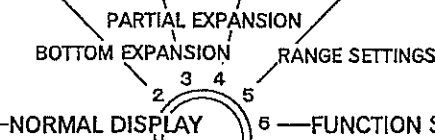

MODE SELECTION DIAL

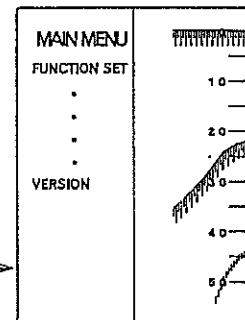

FUNCTION SETTING MENU

• Refer to the Display Modes in page 58 for the combination screens.

# 1. NORMAL MODE

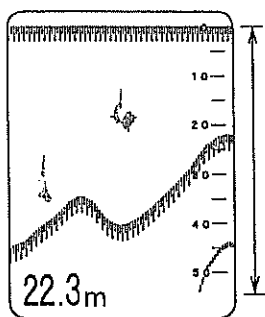

NORMAL MODE

This range can be adjusted by means of the Range keys.



RANGE

- Normal mode is displayed on the full screen.

This is the standard presentation.

# 2. BOTTOM EXPANSION MODE

SCREEN DIV: HORIZ

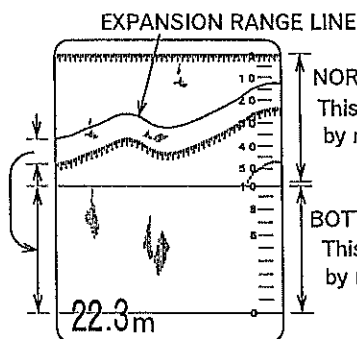

EXPANSION RANGE LINE

NORMAL MODE

This range can be adjusted by means of the Range keys.

BOTTOM EXPANSION MODE

This range can be adjusted by means of the Exp.Range keys.

- Normal mode is displayed on the upper half of the screen, and Bottom expansion mode is displayed on the lower half.

- When SCREEN DIVISION - VERTICAL is selected, you will see Normal mode on the right half of the screen and Bottom expansion mode on the left half of the screen.

- The range of the expansion display is indicated on the normal display by a line.

The expansion range can be adjusted with the expansion range key.

SCREEN DIV: VERT

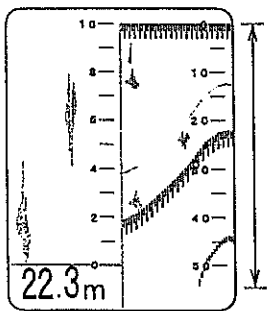

The range of the right side of the screen (Normal mode) can be adjusted by means of the Range keys.

The range of the left side of the screen (Bottom expansion mode) can be adjusted by means of the Exp. Range keys.



EXP

BOTTOM EXPANSION MODE

NORMAL MODE



### 3. PARTIAL EXPANSION MODE

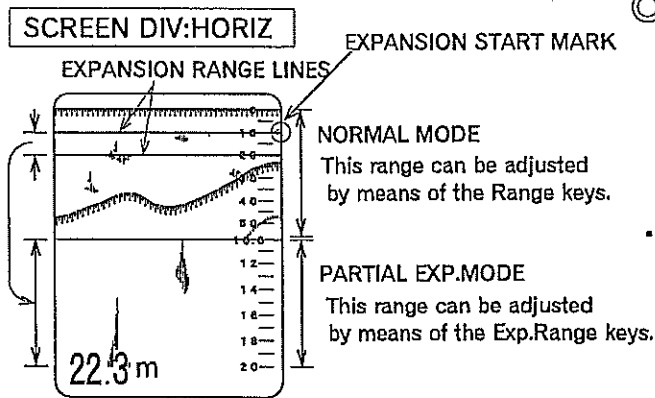

⊙ Normal mode is displayed on the upper half of the screen, and Partial expansion mode is displayed on the lower half.

- When SCREEN DIVISION - VERTICAL is selected, you will see Normal mode on the right half of the screen and Partial expansion mode on the left half of the screen.

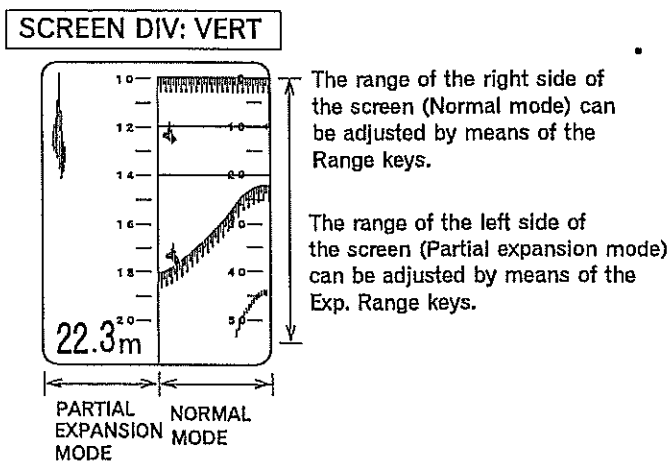

- The range of the expansion display is indicated on the normal display by two lines indicating the upper and lower limits. The upper limit can be adjusted with the Expansion start mark.

The lower limit can be adjusted with the Expansion range key. **CF** Page 69/75

### 4. NAVIGATION (DATA) DISPLAY MODE

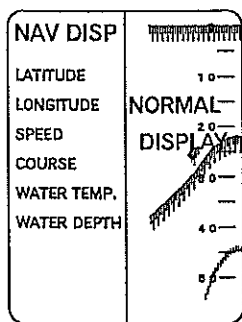

⊙ Normal mode is displayed on the right half of the screen. Navigation data is displayed on the left half of the screen.

#### NOTE !

⊙ Navigation data is only available when ES-7100 is connected to an optional equipment.

⊙ Water temperature data is only available when the ES-7100 is connected to an optional water temperature sensor.

## 5. RANGE SETTINGS

- ◎ To display the RANGE SET MENU.
  - To customized the ranges of the Main range for Normal mode and Sub range for Partial expansion mode in split screen, the desired ranges can be adjusted by means of the Range keys and the Exp. range keys. Open "RANGE SET MENU" and set the desired ranges before operating this nit, if any changes are required. **CF** Page 19/20

RANGE SET MENU		
MAIN RANGE		
NUMBER	RANGE	
1	000	- 0025
2	000	- 0050
3	000	- 0100
4	000	- 0150
5	000	- 0200
6	000	- 0300
7	000	- 0500
SUB RANGE		
NUMBER	RANGE	
1	0001	
2	0002	
3	0005	
4	0010	
5	0020	
6	0030	
7	0040	
8	0050	

## 6. MAIN MENU

- ◎ To display the Main Menu.
  - To set up a fundamental function.
  - To customized the functions, set the desired functions by calling up the proper display before operating this unit. **CF** Page 21

MAIN MENU	
FUNCTION SET	LOW
FUNCTION SET	HIGH
REDUCTION	
SCREEN DIVISION	
DISP ITEM SEL.	
UNIT	ADJUST
OTHERS	
ALARM	
VERSION	

## BRIGHTNESS DIAL

◎ You can change the brightness with this dial.

Further turning in a clockwise direction increases screen brightness.

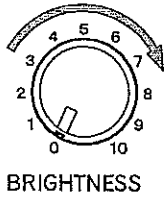

## GAIN DIAL

- ◎ To adjust the level of sensitivity of the received echo signal.
- Turning the dial clockwise increases the gain level, keep turning the dial until the sea bottom is shown in red.

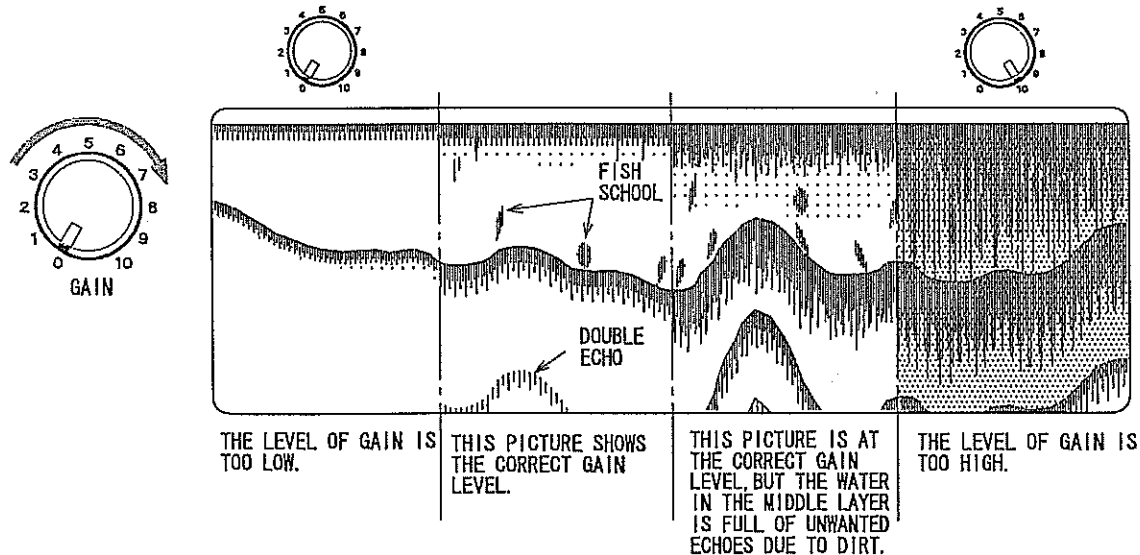

- The strongest echoes are displayed in red and as the received echoes get weaker they are indicated as follows; red → orange → yellow → green → light green → blue → light blue (when color scale A1 or A2 is selected).
- When the target is the sea bottom the gain level setting can be low because the echo from the sea bottom is very strong. However, when the target is fish the level of gain must be increased to pick up the weaker echo. Increasing the gain too much will display unwanted echoes from bubbles and plankton etc.
- If the sea bottom echo is weak due to seaweed, mud etc. adjust the gain level to pick up the weaker echo.
- When passing over the transducer face, bubbles reflect the sound wave and appear as echoes on the screen. In this case, no echoes (fish school) may be displayed even though at a maximum gain level.

### NOTE !

- ◎ Use GAIN UP on the FUNCTION SET MENU to control the variable gain ranges. **CF** Page 22

## FAR GAIN DIAL

☉ To adjust the level of TVG CURVE selected in the function set menu.

**CF** Page 23

### 1. Selection of TVG CURVE (1 ~ 4)

☉ To control the level of the sensitivity of the received deep echo signal.

- Turning the dial clockwise does not increase the gain level close to the transducer but increases the gain level as the depth increases.
- For further true display, it corrects the display differences between the shallow echo and the deep echo.
- The sensitivity achieved using this dial influences the sensitivity achieved using the GAIN DIAL and TVG CURVE function on FUNCTION SET MENU. **CF** Page 23/65

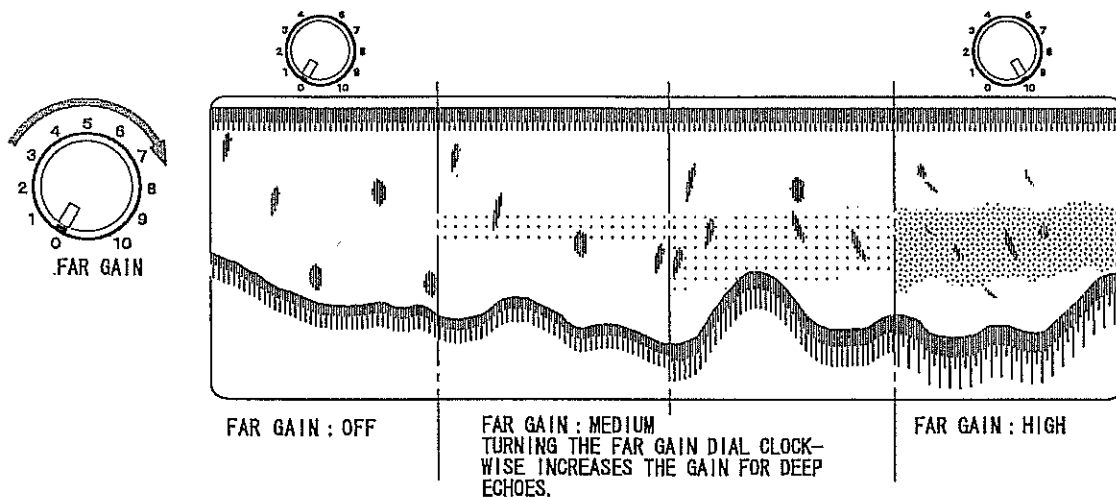

### WHAT IS "FAR GAIN"?

- ☉ The power of the sound wave is absorbed at a certain rate when travel through the water. The higher the frequency, the higher the rate of absorption. For example after travelling 1 kilometer the power of a 50kHz sound wave will decrease to 1/8 of its original strength. The power of a 200kHz sound wave will decrease to 1/300 of its original strength. Use this FAR GAIN dial to counteract the absorption effect by increasing received echo signal of deep echoes

## 2. Selection of " STC - Sensitivity Time Control ".

- To reduce receiver gain for shallow water echoes and restores it with depth in such a manner as to equalize echo strengths at different depths.
- This initial gain suppression is at maximum in the fully counterclockwise position.
- Use this function effectively by adjusting gain value and GAIN UP function.

CF Page 22/65

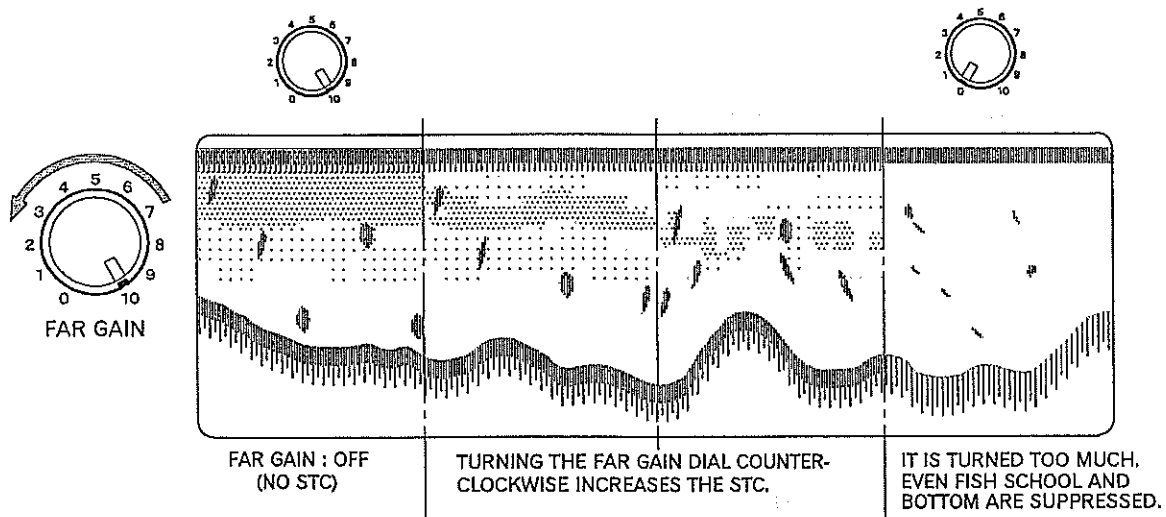

- In case of using FAR GAIN DIAL as STC function there is no effect at the dial 10 and increase the effect as turning the dial into the dial 0.

At this time turning too much to counterclockwise suppresses even fish school or bottom signal.

# KEY OPERATION

## OPERATION MODE KEYS

- ◎ Use these keys to select one of the 3 kinds of operation mode you have selected. In addition to these 3 kinds 3 more kinds are available by accessing MAIN MENU-OTHERS-OPE.MODE. **CF** Page 49

By pressing one of these keys the desired operation mode can be set immediately.

The time when holding one of these 3 keys for two seconds until a beep sounds, the presented setting menu will be stored in the memory. Note that they will not be stored if you release the key before a beep sounds.

Press one of the keys to activate this function, however it will not be accessed and 3 beeps will sound if the pressed key has no data.

During the operation the settings can be changed by using menu or keys, however note that they will not be stored and return to the previous operation mode by pressing one of these 3 keys again.

## MEMORY WRITE / READ KEYS

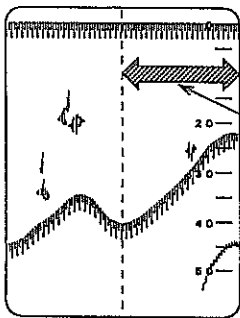

PRESS THIS KEY TO MEMORIZE THIS HALF OF THE SCREEN.



MEMORY WRITE KEY

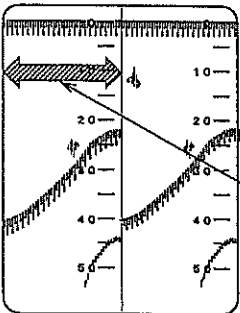

WHEN THIS KEY IS PRESSED, THE MEMORIZED DATA WILL BE DISPLAYED HERE.





MEMORY READ KEY

- ◎ To memorize the right half of the screen.

- Each press of the  Memory write key will memorize the right half of the screen, erasing the last memorized data.

- ◎ To display the memorized data above.

- Pressing the  Memory read key will display the above memorized data on the left half of the screen.
- When the  Memory read key is pressed again the data will be erased from the screen.



- ◎ The memorized data will be erased when the power is turned off.

## EXPANSION / VRM KEY

- ◎ To active the settings adjusted by MAIN MENU - DISP ITEM SEL, EXP/VRM. **CF** Page 33

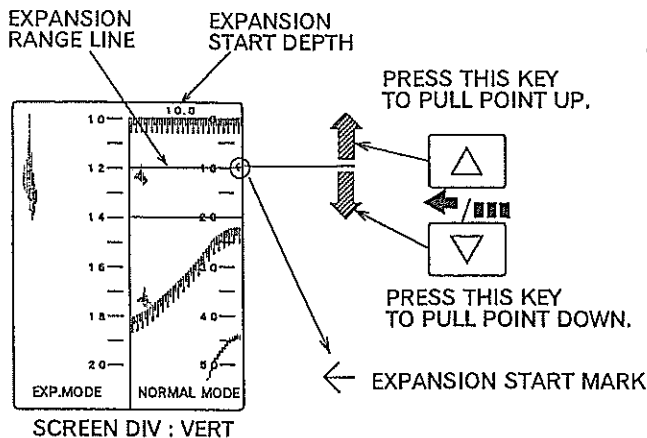

### 1. EXPANSION START POINT

- ◎ To set the expansion start point for Partial expansion mode.





- The numeral expansion start depth will be displayed on the upper corner of the screen.

### 2. VRM line

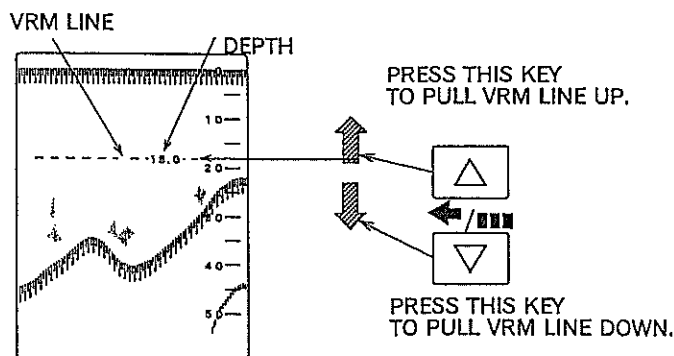
- ◎ If you want to monitor a particular depth in greater detail then the marker line is a very convenient method. It also allows you to change the depth monitored merely by changing the marker line position using the  or  EXP/VRM key.



- Pressing both  &  keys at the same time alternates VRM line on with off.



# RANGE KEYS

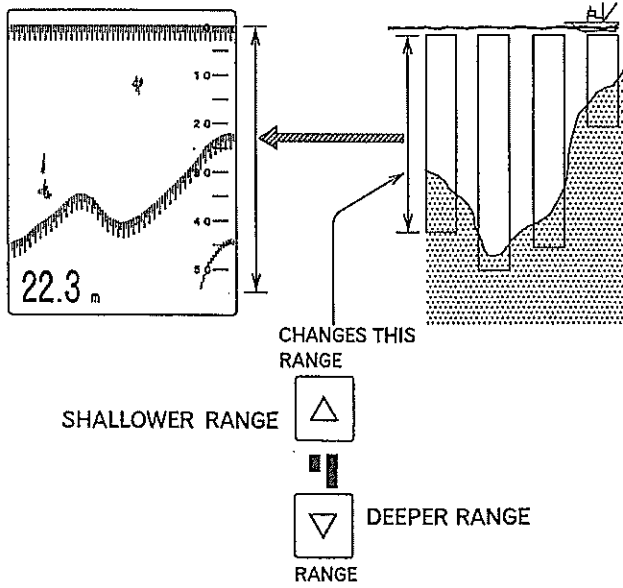

◎ The level can be selected in seven steps.  
**CF** Page 19

• The following shows Factory setting range.

- 1 : 0 ~ 25
- 2 : 0 ~ 50
- 3 : 0 ~ 100
- 4 : 0 ~ 150
- 5 : 0 ~ 200
- 6 : 0 ~ 300
- 7 : 0 ~ 500

• Auto range will be explained in the next page.

# PHASED RANGE KEYS

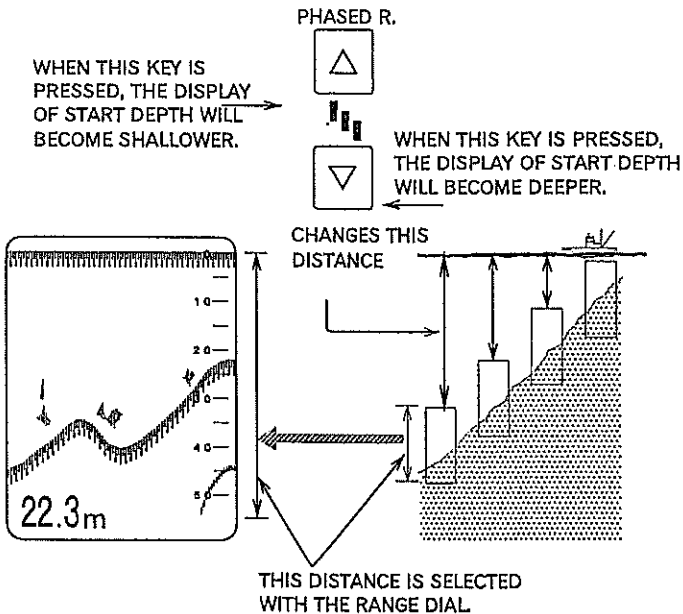

◎ For the selection of the depth start point at the top of the screen.

• Phased range is available in 1 unit step (0 to 999).





This function may be used to show the desired area expanded on the screen. **CF** Page 49

• Auto shift will be explained in the next page.

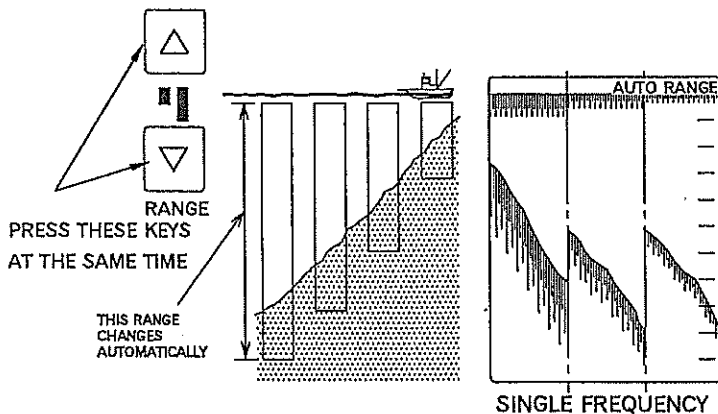
## AUTO RANGE FUNCTION

- ⊙ The range will change automatically to always show the full depth from transducer face to sea bottom regardless of changes in depth.





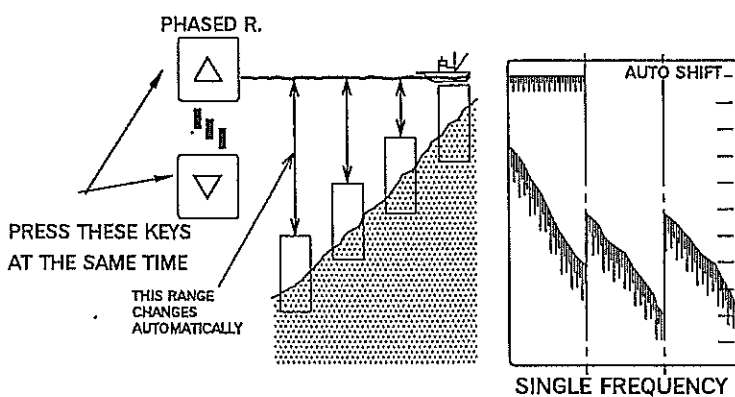

- Press both  &  range keys at the same time to start the auto range function.
- When this function is activated, "AUTO RANGE" will be displayed in the right of the top screen.
- Press both  &  range keys at the same time to release the auto range function.

## AUTO SHIFT FUNCTION

- ⊙ The phased range will change automatically to always track the bottom in the specified range.



- Press both the  &  <sup>PHASED R.</sup> Phased range keys at the same time to start the auto shift function. When this function is activated, "AUTO SHIFT" will be displayed in the right of the top screen.
- Press both  &  <sup>PHASED R.</sup> Phased range keys at the same time to release the auto shift function.
- Refer to ASHIFT LIMIT Page 50 

### NOTE !

- ⊙ For auto range and auto shift functions to work successfully, the sea bottom echo must be in red or orange which are the strongest scale colors.
- ⊙ Even when the sea bottom echo is in red or orange, if there is interference due to bubbles etc., the function may not be able to track the bottom. In this case, if the bottom is not located after 16 transmissions, the depth scale will return to 0 and start searching again. If the function is unable to locate the bottom the scale will continue to fluctuate.

# PICTURE SPEED KEY

◎ The picture speed rate may be selected from the following.

- Each press of the  key changes the setting.

P F 0 (stop)   P F 1 (1/1)   P F 2 (1/2)   P F 3 (1/4)   P F 4 (1/8)

on the full display screen  
(Fig. 1 ~ 3)

P F 2 X (2/1)   P F 3 X (3/1)   P F 4 X (4/1)  
on the full display screen (Fig. 5)

P F 5 (1/4+1/1)   P F 6 (1/8+1/2)   P F 7 (1/16+1/4)   P F 8 (1/32+1/8)

Standard picture speed on the right half of the screen and the compressed picture on the left half of the screen. (Fig. 4)

However this function is not available on an expansion display in split display.

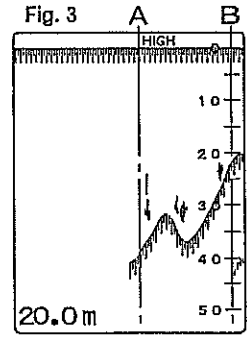
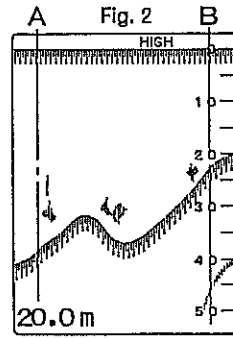
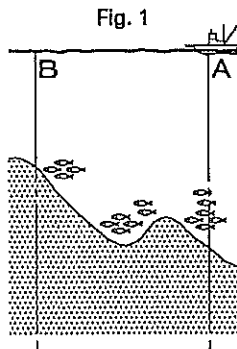
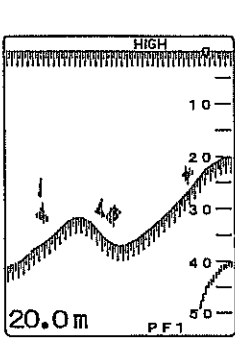

- [ Selection of P F 1 ~ P F 4 (1/1 ~ 1/8) ]

As you see in the Fig.1 the ship travels from point A to B.

In case of the higher rate of movement of the targets on the display screen, moving from right to left, it will be adjusted like Fig.2. and in case of the lower rate of movement of the targets on the display screen, it will be adjusted like Fig.3.

- [ Selection of P F 5 ~ P F 8 ]  
(1/4+1/1 ~ 1/32+1/8)

- [ Selection of P F 2X ~ P F 4X ]  
(2/1 ~ 4/1)

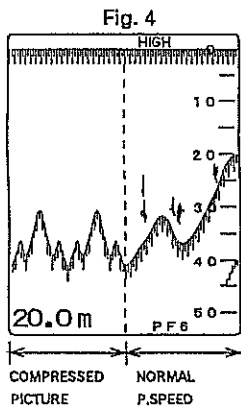

Normal P. speed on the right half of the screen. Lower than the rate of the right half is available on the left half of the screen.

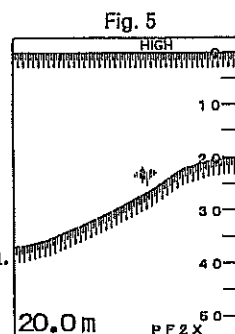

In case of the higher rate of movement than 1/1, the horizontally expanded picture will be displayed as you see in Fig.5.

## WHAT IS PICTURE SPEED ?

- ⊙ Picture speed rate refers to the speed the picture travels from right to left on the screen. 1/1 refers to 1 vertical line of picture per 1 sound transmission, and 1/2 refers to 1 vertical line of picture per 2 sound transmissions. Furthermore 2/1 refers to 2 vertical lines of picture per 1 sound transmission, and 4/1 refers to 4 vertical lines of picture per 1 sound transmission.
- There is no relation to ship speed.

## MARK KEY

- ⊙ Select "MARK" from DISP ITEM SEL. (DISPLAY ITEM SELECTION) to set the desired functions. cf Page 37

### 1. MARK

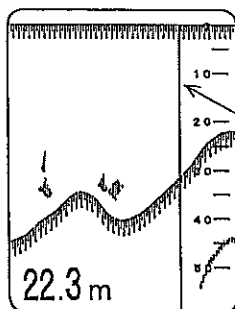

PRESS THIS KEY TO  
DISPLAY A LINE AT  
THE RIGHT EDGE  
OF THE DISPLAY.

- ⊙ To mark a line on the display.
- Pressing this key | will set a yellow vertical line at the right edge of the display.

### 2. TIMER

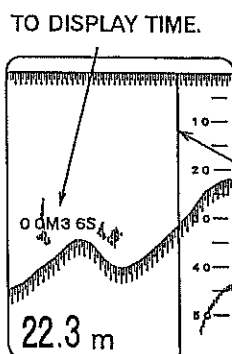

PRESS THIS KEY TO  
START TO TIME.

- ⊙ To time between the two lines.
- Pressing this key | will start to time.
  - On the second pressing this key |, it stops to time.
  - On the third pressing this key |, it erases the display of timer.

## THRESHOLD KEY

- ◎ To remove and recall weaker echoes by color scale from the screen.
  - Each time this key  is pressed the weakest color will be erased.

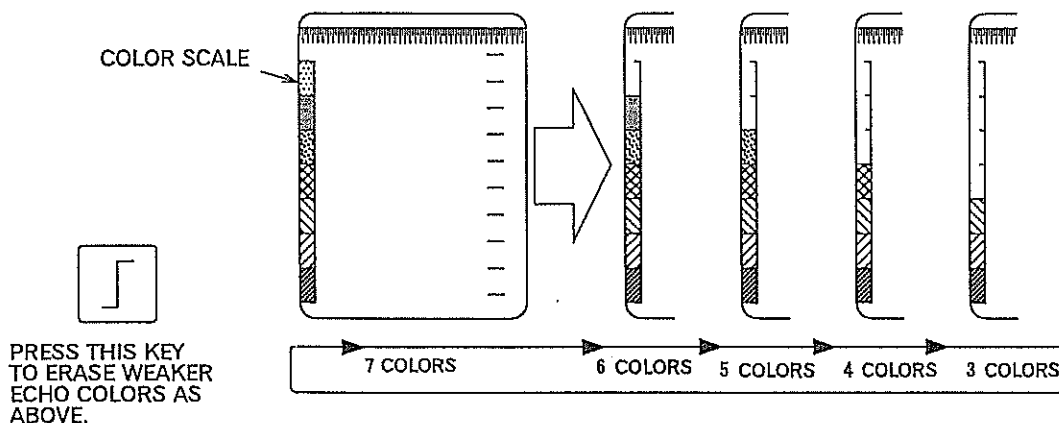

### WHAT IS "THRESHOLD" ?

- ◎ The equipment will pick up and display unwanted echoes from small objects in the water. With the threshold function it is possible to eliminate these unwanted echoes from the screen

## HIGH/LOW FREQUENCY KEYS

- ◎ The most settings for adjusting the presentation of the high or low frequency echo picture are accessed by these keys individually.

**CF** Page 51

- Select "MAIN MENU - OTHERS - RANGE SET - SINGLE"

 : By pressing this key "HIGH" on the top of the screen is highlighted and enables the settings for high frequency presentation to change.

 : By pressing this key "LOW" on the top of the screen is highlighted and enables the settings for low frequency presentation to change.

In case of "MAIN MENU - OTHERS - RANGE SET - LINKED" neither HIGH nor LOW is highlighted.

## EXPANSION RANGE KEY

◎ For selection of the expansion range for Partial or Bottom expansion modes.

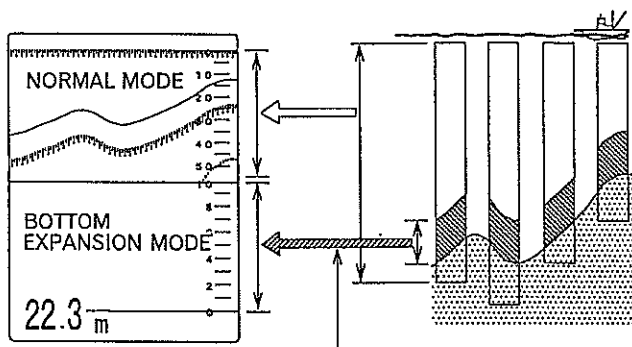

VARIABLE RANGE

SHORTEN THE RANGE



EXPANSION RANGE KEY



WIDEN THE RANGE

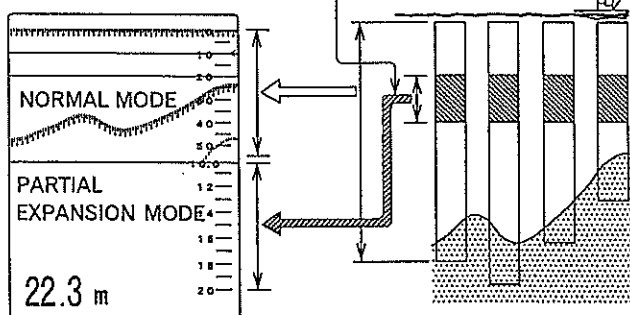

• 8 expansion ranges may be selected with the Expansion range keys as follows.

1:	1
2:	2
3:	5
4:	10
5:	20
6:	30
7:	40
8:	50

The range values can be changed as shown in the page 20.

# Chapter 5

## OPTION

This chapter explains optional connections.

### OPTION & OPTIONAL CONNECTOR KIT

- ◎ To meet various purposes the following connector kits are available as options.
- These kits are intended for connection of the ES-7100's internal PCB to the rear panel and for carrying the signal from external equipment's connection point to the ES-7100's PCB.

NAME		DETAILS	CONNECTION	
OP-305	NAV-IN CONNECTOR KIT	NMEA-0183 input sentences or connecting an external navigational equipment.	No 1: SIGNAL IN + No 2: SIGNAL IN - No 3: SHIELD	No 4: SIGNAL OUT + No 5: SIGNAL OUT -
OP-296	NMEA-OUT CONNECTOR KIT	NMEA-0183 output sentences (depth/water temperature)	No 1: NC No 2: NC No 3: SHIELD	No 4: SIGNAL OUT + No 5: SIGNAL OUT - No 6: NC
OP-298	EXTERNAL SOUNDER CONNECTOR KIT	received signal trigger signal	No 1: TRIGGER IN No 2: TRIGGER OUT No 3: H.FREQ.SIG.IN No 4: H.FREQ.SIG.OUT	No 5: GND No 6: L.FREQ.SIG.IN No 7: L.FREQ.SIG.OUT No 8: SHIELD

## INTERFACE CONNECTIONS

- ◎ The ES-7100 must be turned off while connecting/disconnecting the interface cables.
- ① Release the 4 tapping screws securing the case cover and the front case and the 8 screws securing the case cover and the rear case. Pull the case cover into the direction of an arrow (the rear of the main unit). Refer to Fig. 1.
- ② Release the canoe clip and the cap on IN/OUT terminal. Refer to Fig. 2.
- ③ Insert the receptacle of the terminal from the inside of the rear plate and secure them with the nuts and the screws.
- ④ Release the 8 screws (4 on the upper and 4 on the lower) marked ○ in the Fig. 2 and then remove the chassis from the front case so that the Main board can be easily connected to each terminal.  
NMEA OUT terminal → J2      NAV-IN terminal → J9  
TRIGGER/SIGNAL IN/OUT terminal → J14
- ⑤ Return the chassis and tighten with 8 screws released above.

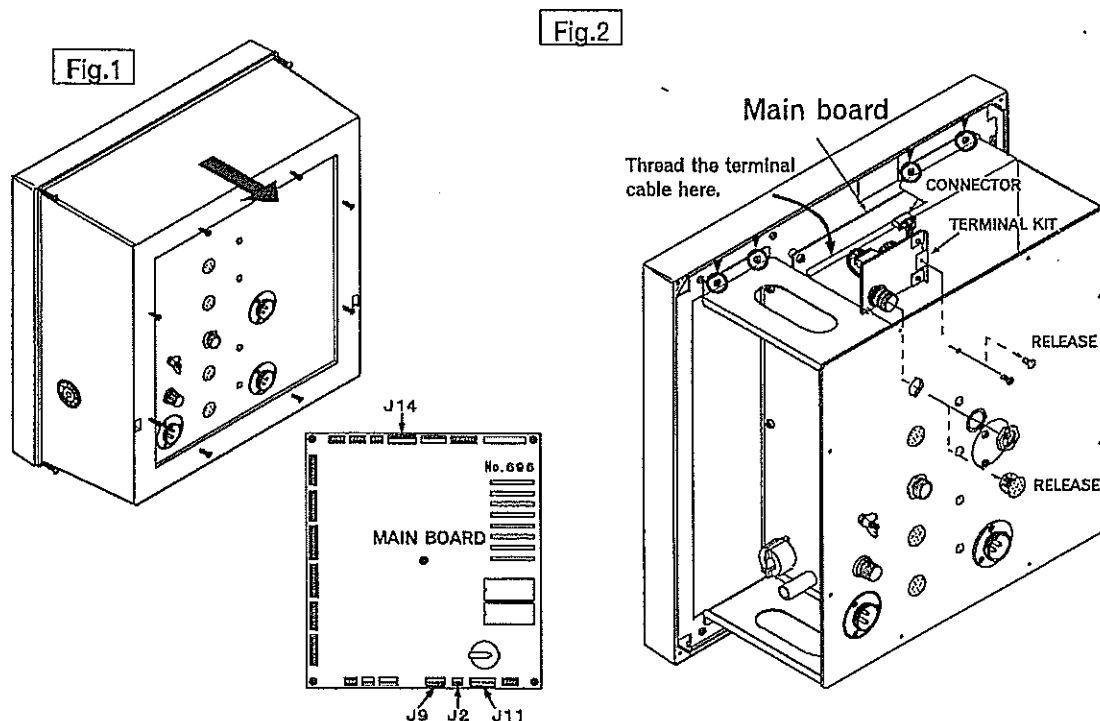

- ◎ Never open the main unit case.  
Electrical shock, damage, and serious bodily injury to user may result. If the ES-7100 requires servicing or installing the terminals, call your authorized SUZUKI dealers.



# SPECIFICATIONS

---

## Specifications 1)

1. DISPLAY RANGES: in 7 steps. ( m, fm, br and ft can be selected in Menu freely to Max 3000m)  
FACTORY SETTING :  
25 · 50 · 100 · 150 · 200 · 300 · 500 m, fm, br.  
50 · 100 · 150 · 200 · 300 · 500 · 1000 ft.
2. PHASED RANGES: from 0 to 999 m, fm and br. from 0 ~ 2999 ft.
3. BOTTOM EXPANSION 1 unit (m, fm and br. ) in 8 steps freely.  
PARTIAL EXPANSION 5 unit (ft.) in 8 steps freely.
4. FREQUENCY 20, 24, 28, 40, 38, 45, 50, 60, 68, 75, 80, 150, or 200kHz (Dual frequency)
5. DISPLAY MODES High frequency only, Low frequency only, Dual display (Vertical/Horizontal)  
Normal/Bottom expansion mode, Normal/Partial expansion mode,  
+A scope mode, Navigation/sounder dual display, Range setting/sounder display,  
Function settings/sounder display. + Color Palette.
6. DISPLAY DATA Depth scale · Depth (3 steps) · Water temp. \* (2 steps)  
Water temp. scale · Expansion start depth · VRM · Marker line  
Lat/Long \* · Ship's speed \* · Course \*
7. FUNCTION SET Picture speed · Interference reduction · High/Low frequency · Auto range  
DISPLAY Auto shift
8. ADDITIONAL DISPLA Second Interval Mark · Color scale · Water temp graph \* · Marker line  
Expansion range line · Expansion start marker · TX power
9. OTHER FUNCTIONS Operation mode (3 kinds in 2 segments) · Major measuring frequency  
TVG curve · Gain · Far gain · Interference reduction · Jamming reduction  
Noise reduction · White line · STC · Clutter control · Threshold key  
Auto range · Auto shift · Display position · Depth grid · Draft adjust  
Water temp. adjust · Outer depth · Pulth width · Screen memory  
Stop watch function · TX power · Brightness · Depth/Temp. display position  
User setting · Expansion mode (4 modes) · Color selection · Color palette  
Alarms (shallow/deep/fish) · Alarms (temperature) · Data backup system

## Specifications 2)

1. DISPLAY TFT color, 10.4 inch=480x640 pixels
2. POWER SUPPLY 10.5-40Vdc 30 Watts
3. INPUT Temp. sensor (OP-102 or OP-41)\* Temp. data (vis NMEA-0183)\*  
Navigation data (via NMEA-0183)\*  
External sounder (Trigger signal, Signal IN-OUT)
4. OUTPUT Depth data (via NMEA-0183) \*  
Water Temp. data (via NMEA-0183)  
External sounder (Trigger signal, Signal IN-OUT)

NOTE: Functions marked with an asterisk \* require optional equipment.